

Pioneer *sound.vision.soul*

**AUDIO/VIDEO MULTI-CHANNEL
RECEIVER**

VSX-D712

VSX-D812

Operating Instructions

WARNING: THE APPARATUS IS NOT WATERPROOFS, TO PREVENT FIRE OR SHOCK HAZARD, DO NOT EXPOSE THIS APPLIANCE TO RAIN OR MOISTURE AND DO NOT PUT ANY WATER SOURCE NEAR THIS APPARATUS, SUCH AS VASE, FLOWER POT, COSMETICS CONTAINER AND MEDICINE BOTTLE ETC.

H001AEn

[For Canadian model]

CAUTION: TO PREVENT ELECTRIC SHOCK, DO NOT USE THIS (POLARIZED) PLUG WITH AN EXTENSION CORD, RECEPTACLE OR OTHER OUTLET UNLESS THE BLADES CAN BE FULLY INSERTED TO PREVENT BLADE EXPOSURE.

ATTENTION: POUR PREVENIR LES CHOCS ELECTRIQUES NE PAS UTILISER CETTE FICHE POLARISEE AVEC UN PROLONGATEUR UNE PRISE DE COURANT OU UNE AUTRE SORTIE DE COURANT, SAUF SI LES LAMES PEUVENT ETRE INSEREES A FOND SANS EN LAISSER AUCUNE PARTIE A DECOUVERT.

H007A2L

[For Canadian model]

This Class B digital apparatus complies with Canadian ICES-003.

[Pour le modèle Canadien]

Cet appareil numérique de la classe B est conforme à la norme NMB-003 du Canada.

H009 2L

If the socket outlets on the associated equipment are not suitable for the plug supplied with the product, the plug must be removed and an appropriate one fitted. Replacement and mounting of an AC plug on the power supply cord of this unit should be performed only by qualified service personnel. The cut-off plug must be disposed of as an electrical shock hazard could exist if connected to a socket outlet.

H022AEn

[For U.S. model]



ENERGY STAR® and the ENERGY STAR certification mark are registered US marks.

K001A_En

CAUTION:

THE STANDBY/ON BUTTON IS SECONDARY CONNECTED AND THEREFORE DOES NOT SEPARATE THE UNIT FROM MAINS POWER IN STANDBY POSITION. THEREFORE INSTALL THE UNIT SUITABLE PLACES EASY TO DISCONNECT THE MAINS PLUG IN CASE OF THE ACCIDENT. THE MAINS PLUG OF UNIT SHOULD BE UNPLUGGED FROM THE WALL SOCKET WHEN LEFT UNUSED FOR A LONG PERIOD OF TIME.

H017BEn

Thank you for buying this Pioneer product. Please read through these operating instructions so you will know how to operate your model properly. After you have finished reading the instructions, put them away in a safe place for future reference.

IMPORTANT NOTICE

H006AEn

The serial number for this equipment is located in the rear panel. Please write this serial number on your enclosed warranty card and keep it in a secure area. This is for your security.

NOTE: This equipment has been tested and found to comply with the limits for a Class B digital device, pursuant to Part 15 of the FCC Rules. These limits are designed to provide reasonable protection against harmful interference in a residential installation. This equipment generates, uses, and can radiate radio frequency energy and, if not installed and used in accordance with the instructions, may cause harmful interference to radio communications. However, there is no guarantee that interference will not occur in a particular installation. If this equipment does cause harmful interference to radio or television reception, which can be determined by turning the equipment off and on, the user is encouraged to try to correct the interference by one or more of the following measures:

- Reorient or relocate the receiving antenna.
- Increase the separation between the equipment and receiver.
- Connect the equipment into an outlet on a circuit different from that to which the receiver is connected.
- Consult the dealer or an experienced radio/TV technician for help.

H010 En

Information to User

Alteration or modifications carried out without appropriate authorization may invalidate the user's right to operate the equipment.

H011 En

CAUTION:

This product satisfies FCC regulations when shielded cables and connectors are used to connect the unit to other equipment. To prevent electromagnetic interference with electric appliances such as radios and televisions, use shielded cables and connectors for connections.

H012 En

WARNING: Handling the cord on this product or cords associated with accessories sold with the product will expose you to lead, a chemical known to the State of California and other governmental entities to cause cancer and birth defects or other reproductive harm.

Wash hands after handling.

IMPORTANT



The lightning flash with arrowhead symbol, within an equilateral triangle, is intended to alert the user to the presence of uninsulated "dangerous voltage" within the product's enclosure that may be of sufficient magnitude to constitute a risk of electric shock to persons.

CAUTION
RISK OF ELECTRIC SHOCK
DO NOT OPEN

CAUTION:
TO PREVENT THE RISK OF ELECTRIC SHOCK, DO NOT REMOVE COVER (OR BACK). NO USER-SERVICEABLE PARTS INSIDE. REFER SERVICING TO QUALIFIED SERVICE PERSONNEL.



The exclamation point within an equilateral triangle is intended to alert the user to the presence of important operating and maintenance (servicing) instructions in the literature accompanying the appliance.

IMPORTANT SAFETY INSTRUCTIONS

H003 En

READ INSTRUCTIONS — All the safety and operating instructions should be read before the product is operated.

RETAIN INSTRUCTIONS — The safety and operating instructions should be retained for future reference.

HEED WARNINGS — All warnings on the product and in the operating instructions should be adhered to.

FOLLOW INSTRUCTIONS — All operating and use instructions should be followed.

CLEANING — Unplug this product from the wall outlet before cleaning. The product should be cleaned only with a polishing cloth or a soft dry cloth. Never clean with furniture wax, benzene, insecticides or other volatile liquids since they may corrode the cabinet.

ATTACHMENTS — Do not use attachments not recommended by the product manufacturer as they may cause hazards.

WATER AND MOISTURE — Do not use this product near water — for example, near a bathtub, wash bowl, kitchen sink, or laundry tub; in a wet basement; or near a swimming pool, and the like.

ACCESSORIES — Do not place this product on an unstable cart, stand, tripod, bracket, or table. The product may fall, causing serious injury to a child or adult, and serious damage to the product. Use only with a cart, stand, tripod, bracket, or table recommended by the manufacturer, or sold with the product. Any mounting of the product should follow the manufacturer's instructions, and should use a mounting accessory recommended by the manufacturer.

CART — A product and cart combination should be moved with care. Quick stops, excessive force, and uneven surfaces may cause the product and cart combination to overturn.



VENTILATION — Slots and openings in the cabinet are provided for ventilation and to ensure reliable operation of the product and to protect it from overheating, and these openings must not be blocked or covered. The openings should never be blocked by placing the product on a bed, sofa, rug, or other similar surface. This product should not be placed in a built-in installation such as a bookcase or rack unless proper ventilation is provided or the manufacturer's instructions have been adhered to.

POWER SOURCES — This product should be operated only from the type of power source indicated on the marking label. If you are not sure of the type of power supply to your home, consult your product dealer or local power company.

LOCATION — The appliance should be installed in a stable location.

NONUSE PERIODS — The power cord of the appliance should be unplugged from the outlet when left unused for a long period of time.

GROUNDING OR POLARIZATION

- If this product is equipped with a polarized alternating current line plug (a plug having one blade wider than the other), it will fit into the outlet only one way. This is a safety feature. If you are unable to insert the plug fully into the outlet, try reversing the plug. If the plug should still fail to fit, contact your electrician to replace your obsolete outlet. Do not defeat the safety purpose of the polarized plug.

- If this product is equipped with a three-wire grounding type plug, a plug having a third (grounding) pin, it will only fit into a grounding type power outlet. This is a safety feature. If you are unable to insert the plug into the outlet, contact your electrician to replace your obsolete outlet. Do not defeat the safety purpose of the grounding type plug.

POWER-CORD PROTECTION — Power-supply cords should be routed so that they are not likely to be walked on or pinched by items placed upon or against them, paying particular attention to cords at plugs, convenience receptacles, and the point where they exit from the product.

OUTDOOR ANTENNA GROUNDING — If an outside antenna or cable system is connected to the product, be sure the antenna or cable system is grounded so as to provide some protection against voltage surges and build-up static charges. Article 810 of the National Electrical Code, ANSI/NFPA 70, provides information with regard to proper grounding of the mast and supporting structure, grounding of the lead-in wire to an antenna discharge unit, size of grounding conductors, location of antenna-discharge unit, connection to grounding electrodes, and requirements for the grounding electrode. See Figure A.

LIGHTNING — For added protection for this product during a lightning storm, or when it is left unattended and unused for long periods of time, unplug it from the wall outlet and disconnect the antenna or cable system. This will prevent damage to the product due to lightning and power-line surges.

POWER LINES — An outside antenna system should not be located in the vicinity of overhead power lines or other electric light or power circuits, or where it can fall into such power lines or circuits. When installing an outside antenna system, extreme care should be taken to keep from touching such power lines or circuits as contact with them might be fatal.

OVERLOADING — Do not overload wall outlets, extension cords, or integral convenience receptacles as this can result in a risk of fire or electric shock.

OBJECT AND LIQUID ENTRY — Never push objects of any kind into this product through openings as they may touch dangerous voltage points or short-circuit parts that could result in a fire or electric shock. Never spill liquid of any kind on the product.

SERVICING — Do not attempt to service this product yourself as opening or removing covers may expose you to dangerous voltage or other hazards. Refer all servicing to qualified service personnel.

DAMAGE REQUIRING SERVICE — Unplug this product from the wall outlet and refer servicing to qualified service personnel under the following conditions:

- When the power-supply cord or plug is damaged.
- If liquid has been spilled, or objects have fallen into the product.
- If the product has been exposed to rain or water.
- If the product does not operate normally by following the operating instructions. Adjust only those controls that are covered by the operating instructions as an improper adjustment of other controls may result in damage and will often require extensive work by a qualified technician to restore the product to its normal operation.
- If the product has been dropped or damaged in any way.
- When the product exhibits a distinct change in performance — this indicates a need for service.

REPLACEMENT PARTS — When replacement parts are required, be sure the service technician has used replacement parts specified by the manufacturer or have the same characteristics as the original part. Unauthorized substitutions may result in fire, electric shock, or other hazards.

SAFETY CHECK — Upon completion of any service or repairs to this product, ask the service technician to perform safety checks to determine that the product is in proper operating condition.

WALL OR CEILING MOUNTING — The product should not be mounted to a wall or ceiling.

HEAT — The product should be situated away from heat sources such as radiators, heat registers, stoves, or other products (including amplifiers) that produce heat.

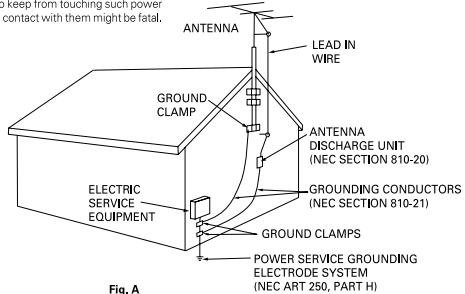

Fig. A

NEC — NATIONAL ELECTRICAL CODE

Manufactured under license from Dolby Laboratories. "Dolby", "Pro Logic", "Surround EX", and the double-D symbol are trademarks of Dolby Laboratories.

"DTS", "DTS-ES Extended Surround" and "Neo:6" are trademarks of Digital Theater Systems, Inc.

Contents

01 Before you start

Checking what's in the box	6
Installing the receiver	6
Making cable connections	6
Loading the batteries	6
Operating range of the remote control unit	7

02 5 minute guide

Introduction to home theater	8
Listening to Surround Sound	9
Using the Quick Setup	13

03 Connecting up

Audio/Video cords	15
S-video cables	15
Component video cords	15
Digital audio coaxial cords/ Optical cables	15
Connecting digital components	16
Connecting audio components	17
Connecting DVD multi-channel components	18
Connecting video components	19
Connecting to the front panel video terminal	19
Connecting antennas	20
FM wire antenna	20
AM loop antenna	20
Using external antennas	20
Connecting the speakers (VSX-D712)	21
Connecting the speakers (VSX-D812)	22
Speaker terminals	23
A and B speaker systems	23
Hints on speaker placement	23
Connecting additional amplifiers	26
AC outlet	27
Power cord caution	27
Operating other Pioneer components	28

04 Controls and displays

Front panel	29
Display	31
Remote control	33

05 Playing sources

Introduction to Sound Modes	36
Stereo/Direct	36
Standard mode	36
Advanced Surround modes	37
Choosing the input signal	37
Listening to multi-channel playback	38
Using Stereo/Direct	39
Using Advanced Surround	39
Using the Surround Back Channel (SB CH)	40
Using the Virtual Surround Back mode (VSB)	41
Using Midnight and Loudness listening	42
Using the tone controls	42
Playing other sources	42
Selecting the multi-channel analog inputs	43
Using the sleep timer	43

06 Setting up the receiver

Choosing your receiver setup	44
Speaker setting	45
Surround back speaker setting	46
Subwoofer setting	46
Crossover frequency setting	46
LFE attenuator setting	47
Front left speaker distance setting	47
Center speaker distance setting	47
Front right speaker distance setting	48
Surround right speaker distance setting	48
Surround back speaker distance setting	48

Surround left speaker distance setting . . .	48
Subwoofer distance setting	49
Dynamic range control setting	49
Dual mono setting	49
Component video input settings	49
Surround back channel input setting (VSX-D812 only)	50
Digital input settings	50
Manually calibrating your listening area (MCACC)	51
Setting separate channel levels for listening modes	52

07 Using the tuner

Listening to the radio	54
Improving FM stereo sound	54
Tuning directly to a station	54
Saving station presets	55
Naming station presets	56
Listening to station presets	56

08 Making recordings

Making an audio or a video recording	57
--	----

09 Controlling the rest of your system

Setting the remote to control other components	58
Selecting preset codes directly	58
Clearing all the remote control settings . . .	59
Direct function	59
Controls for TVs	60
Controls for other components	61
Preset Code List	63

10 Additional information

Troubleshooting	65
Resetting the main unit	67
Specifications	68
Cleaning the unit	69

Chapter 1: Before you start

Checking what's in the box

Please check that you've received the following supplied accessories:

- AM loop antenna
- FM wire antenna
- AA/R6 dry cell batteries x2
- Remote control
- These operating instructions

Installing the receiver

Please note the following points:

- Do not place objects directly on top of this unit. This prevents proper heat dispersal.
- When installing on a rack, shelf, etc., be sure to leave more than 8 inches (20 cm.) of space above the receiver.

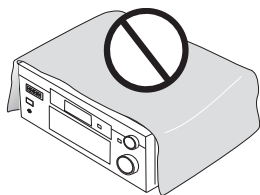

Making cable connections

Make sure not to bend the cables over the top of this unit (as shown in the illustration). If this happens, the magnetic field produced by the transformers in this unit may cause a humming noise from the speakers.

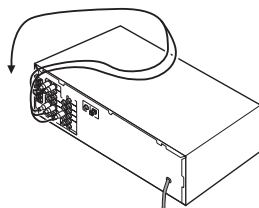

Loading the batteries

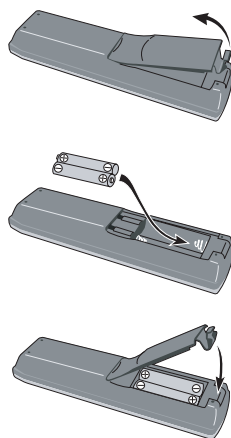

**Important**

Incorrect use of batteries may result in such hazards as leakage and bursting. Observe the following precautions:

- Never use new and old batteries together.
- Insert the plus and minus sides of the batteries properly according to the marks in the battery case.
- Batteries with the same shape may have different voltages. Do not use different batteries together.
- When disposing of used batteries, please comply with governmental regulations or environmental public instruction's rules that apply in your country or area.

Operating range of the remote control unit

The remote control may not work properly if:

- There are obstacles between the remote control and the receiver's remote sensor.
- Direct sunlight or fluorescent light is shining onto the remote sensor.
- The receiver is located near a device that is emitting infrared rays.
- The receiver is operated simultaneously with another infrared remote control unit.

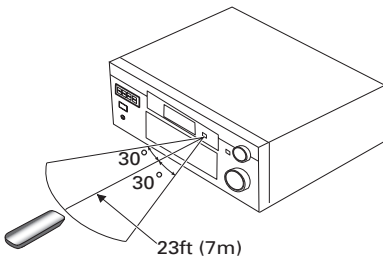

Chapter 2:

5 minute guide

Introduction to home theater

You are probably used to using stereo equipment to listen to music, but may not be used to home theater systems that give you many more options (such as surround sound) when listening to soundtracks.

Home theater refers to the use of multiple audio tracks to create a surround sound effect, making you feel like you're in the middle of the action or concert. The surround sound you get from a home theater system depends not only on the speakers you have set up in your room, but also on the source and the sound settings of the receiver.

DVD-Video has become the basic source material for home theater due to its size, quality, and ease of use. Depending on the DVD, you can have up to seven different audio tracks coming from one disc, all of them being sent to different speakers in your system. This is what creates a surround sound effect and gives you the feeling of 'being there'.

This receiver will automatically decode Dolby Digital, DTS, or Dolby Surround DVD-Video discs, according to your speaker setup. In most cases, you won't have to make changes for realistic surround sound, but other possibilities (like listening to a CD with multi-channel surround sound) are explained in Playing sources on page 36.

Listening to Surround Sound

This receiver was designed with the easiest possible setup in mind, so with the following quick setup guide, you should have your system hooked up for surround sound in no time at all. In most cases, you can simply leave the receiver in the default settings.

Be sure to complete all connections before connecting this unit to the AC power source.

1 Hook up your DVD player.

For surround sound, you'll want to hook up using a digital connection from the DVD player to the receiver. You can do this with either a coaxial, or an optical connection (you don't need to connect both). If you hook up using an optical cable, you should refer to Digital input settings on page 50 to assign the optical input to **DVD**.

Use a video cord to connect the video output on your DVD player to the receiver using the jacks as shown in the illustration.

2 Hook up your TV.

Use a video cord to connect your receiver to the TV using the jacks as shown in the illustration.

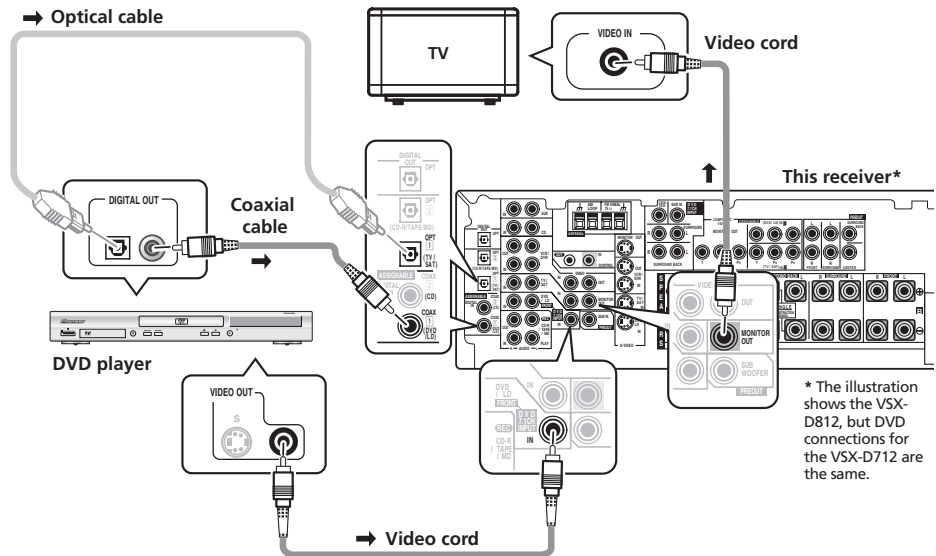

3 Connect your speakers.

A complete setup of speakers is shown here (six speakers for the VSX-D712, and eight for the VSX-D812), but everyone's home setup will vary. Simply connect the speakers you have in the manner shown below. The receiver will work with just two stereo speakers (the front speakers in the diagram) but using at least three speakers is recommended, and a complete setup is best.

Make sure you connect the speaker on the right to the right terminal and the speaker on the left to the left terminal. Also make sure the positive and negative (+/-) terminals on the receiver match those on the speakers.



Important

- Use speakers with a nominal impedance of 8 Ω to 16 Ω .
- If you're not using a subwoofer, change the front speaker setting (see Speaker setting on page 45) to large.

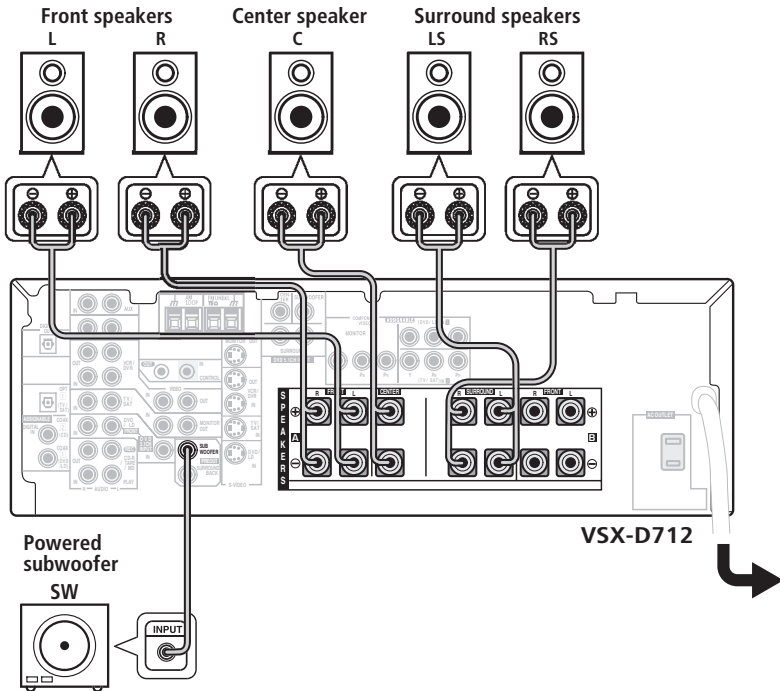

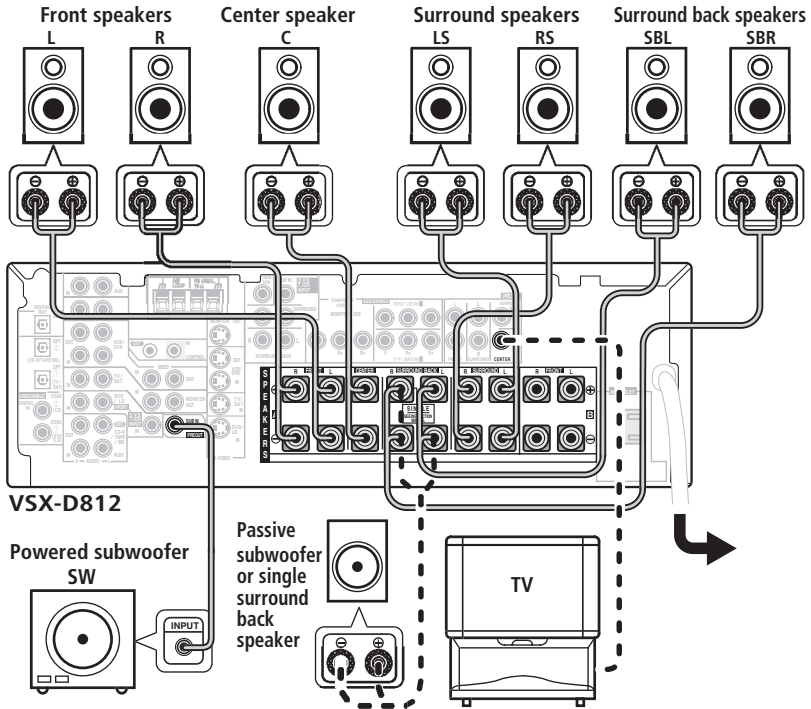

VSX-D812 only

- When using the speaker on your TV as the center speaker (C), connect the **CENTER PREOUT** jack on this unit to the audio input jack on your TV. In this case the center speaker shown is unnecessary.

- If you are using only one surround back speaker, connect the positive wire to the right channel (+) terminal, and the negative wire to the left channel (–) terminal (shown below).
- If you select subwoofer (**SB SW**) in the Surround back speaker setting on page 46 you can hook up a subwoofer instead of speakers to the surround back speaker terminals. Connect the wires just as above (and as shown below), connecting the positive wire to the right channel (+) terminal, and the negative wire to the left channel (–) terminal.

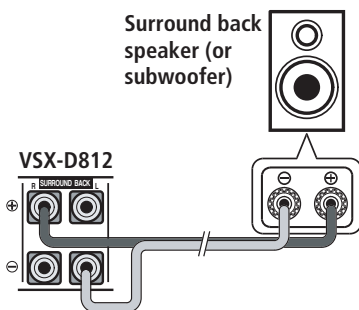

4 Plug in the receiver and switch it on, followed by your DVD player, your subwoofer and the TV.

Make sure you've set the video input on your TV to this receiver. Check the manual that came with the TV if you don't know how to do this.

Also make sure that **DVD/LD** is showing in the receiver's display, indicating that the DVD input is selected. If it isn't, press **DVD/LD** on the remote control to set the receiver to the DVD input.

5 Press QUICK SETUP on the front panel to specify your speaker setup, room size and listening position.

Use the **MULTI JOG** dial to select and **ENTER** to confirm your selection. See Using the Quick Setup on page 13 if you're unsure about the settings.

6 Play a DVD, and adjust the volume to your liking.

There are several other sound options you can select. See Introduction to Sound Modes on page 36 for more on this. See also Choosing your receiver setup on page 44 for more setup options.



Note

- Depending on your DVD player or source discs, you may only get digital 2 channel stereo and analog sound. In this case, the listening mode must be set to **STANDARD** (it should already be set—see Listening to multi-channel playback on page 38 if you need to do this) if you want multi-channel surround sound.

Using the Quick Setup

You can use the Quick Setup to get your system up and running with just a few button presses. The receiver automatically makes the necessary settings after you have selected your speaker setup, room size and listening position. If you want to make more specific settings, refer to Choosing your receiver setup on page 44.

Use the front panel controls for the steps below.

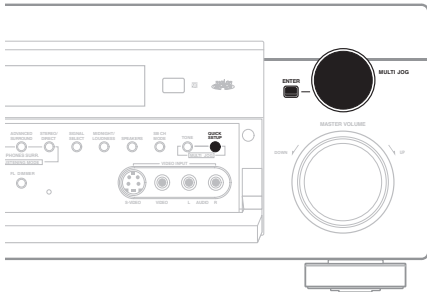

1 If the receiver is off, press  STANDBY/ON to turn the power on.
The **STANDBY** indicator goes out.

2 Press QUICK SETUP.
SW DET flashes in the display while the receiver checks your setup for a subwoofer. **SW YES** or **SW NO** confirms the subwoofer check, then the display prompts you to select your speaker setup.

3 Use the MULTI JOG dial to choose your speaker setup.
When a subwoofer was detected in step 2, you can cycle between the following choices:

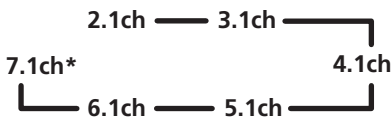

* VSX-D812 only

If a subwoofer wasn't detected in step 2, you can cycle between the following choices:

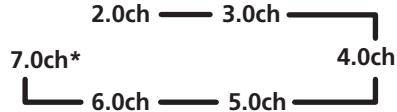

* VSX-D812 only

- Check the table below to find the speaker setup that corresponds with your system.

	Front Speakers	Center Speaker	Surround Speakers	Surround Back Sp.	Sub Woofer
2.0 ch	✓				
2.1 ch	✓				✓
3.0 ch	✓	✓			
3.1 ch	✓	✓			✓
4.0 ch	✓		✓		
4.1 ch	✓		✓		✓
5.0 ch	✓	✓	✓		
5.1 ch	✓	✓	✓		✓
6.0 ch	✓	✓	✓	(1 speaker)	
6.1 ch	✓	✓	✓	(1 speaker)	✓
7.0 ch*	✓	✓	✓	(2 speakers)	
7.1 ch*	✓	✓	✓	(2 speakers)	✓

* VSX-D812 only

4 Press ENTER.

5 Use the MULTI JOG dial to choose your room size.

Depending on the distance of your speakers from the listening position, choose between small, medium, or large (**S**, **M** or **L**), **M** being an average-sized room.

6 Press ENTER.

7 Use the MULTI JOG dial to choose your listening position.

Cycle between the following choices:

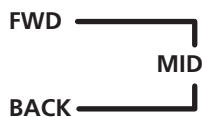

FWD – If you are nearer to the front speakers than the surround speakers

MID – If you are equal distance from the front and surround speakers

BACK – If you are nearer to the surround speakers than the front speakers

8 Press ENTER to confirm your setup.

The display shows the speaker setup, room size and listening position that you've selected.

Chapter 3: Connecting up

Important

- Before making or changing any connections, switch off the power and disconnect the power cord from the AC outlet.

Audio/Video cords

Use audio/video cords (not supplied) to connect the audio/video components and a video cord to connect the monitor TV.

Connect red plugs to R (right), white plugs to L (left), and the yellow plugs to VIDEO.

Be sure to insert completely.

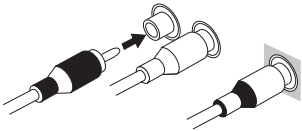

S-video cables

Use S-video cables (not supplied) to get clearer picture reproduction than regular video cords.

Connect from an S-video jack on the rear of the receiver to an S-video jack on the video component you are hooking up.

Be sure to insert completely.

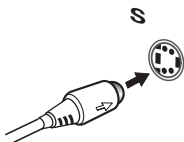

Component video cords

Use component video cords to get the best possible color reproduction of your video source. The color signal of the TV is divided into the luminance (Y) signal and the color (PB and PR) signals and then output. In this way, interference between the signals is avoided. Connect from the component video jacks on the rear of the receiver to the component video jacks on the video component you are hooking up.

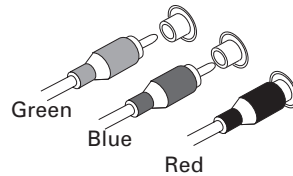

Digital audio coaxial cords/ Optical cables

Commercially available digital audio coaxial cords (standard video cords can also be used) or optical cables (not supplied) are used to connect digital components to this receiver.

Be sure to insert completely.

Digital audio coaxial cord (or standard video cord)

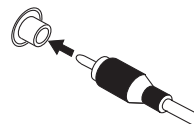

Optical cable

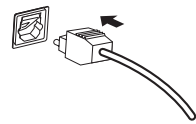

Connecting digital components

The easiest way to hook up this receiver for surround sound is to use a digital input. You can do this by either coaxial or optical connections (you do not need to do both). The quality of these two types of connections is the same but since some digital components only have one type of digital terminal, it is a matter of matching like with like (for example, the coaxial output from the component to coaxial input on the receiver). The VSX-D712 has three digital inputs on the rear panel (two coaxial inputs and an optical input) and the VSX-D812 has four (two coaxial inputs and two optical inputs). Connect your digital components to the rear panel as shown below.

There is one digital output jack which is marked **DIGITAL OUT**. If you connect this to the optical input on a digital recorder (currently these include MD, DAT and CD-R) you can make direct digital recordings with this unit.

When connecting your equipment, always make sure the power is turned off and the power cord is disconnected from the AC outlet.

- The arrows indicate the direction of the signal.

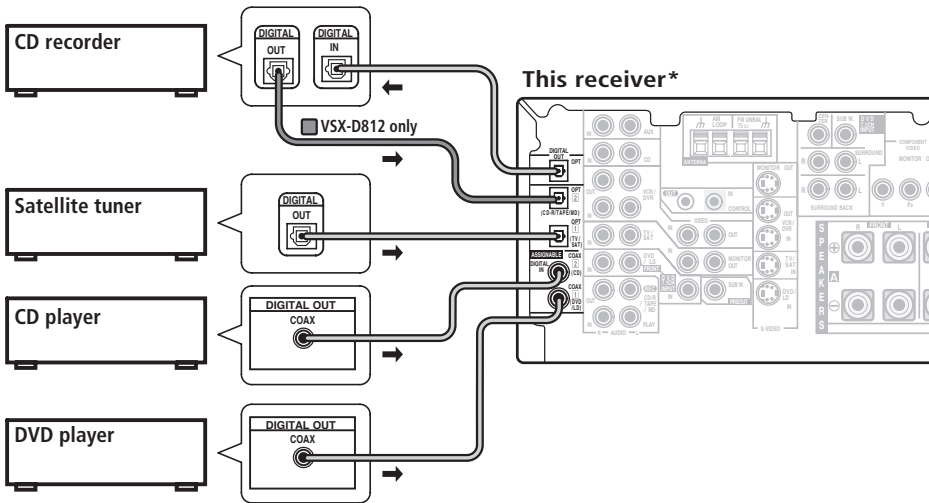

* The illustration shows the VSX-D812, but connections for the VSX-D712 are the same.

 **Note**

- If you have an LD player, you need to make special connections to ensure you can play **DD** RF format LDs on your system. If this is the case, hook up your DVD or LD player directly to an RF demodulator using both the **DD** RF output and either a coaxial or optical digital connection. We also recommend hooking up your digital components to analog audio jacks as well. Make sure the RF demodulator digital in switch is set correctly (optical or coaxial depending on the connection). See the component's instruction manual if you are unsure about its input and output jacks.

Connecting audio components

To begin set up, connect your analog audio components (such as a cassette deck) to the jacks. For components you want to record with, you need to hook up four plugs to the receiver (a set of stereo inputs and a set of stereo outputs), but for components that only play, you only need to hook up one set of stereo plugs. You must also hook up your digital components to analog audio jacks if you want to record to/from digital components (like an MD) to/from analog components. See page 16 for more on digital connections.

When connecting your equipment, always make sure the power is turned off and the power cord is disconnected from the AC outlet.

- The arrows indicate the direction of the signal.

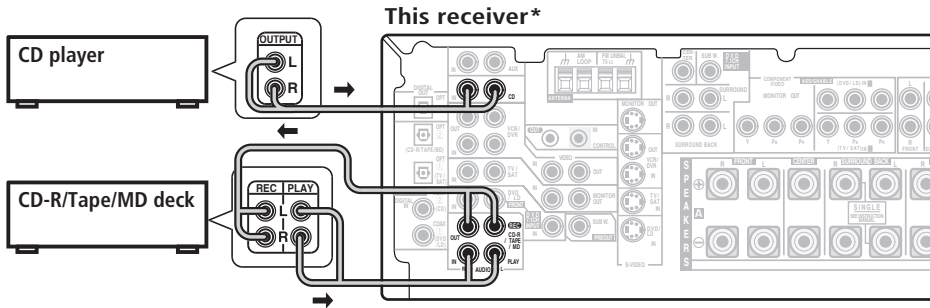

* The illustration shows the VSX-D812, but connections for the VSX-D712 are the same.

Connecting DVD multi-channel components

If you prefer to use a separate component for decoding DVDs, you can connect a decoder or a DVD player with multi-channel analog outputs to the multi-channel inputs of this receiver.

When connecting your equipment, always make sure the power is turned off and the power cord is disconnected from the AC outlet.

- The arrows indicate the direction of the signal.

This receiver*

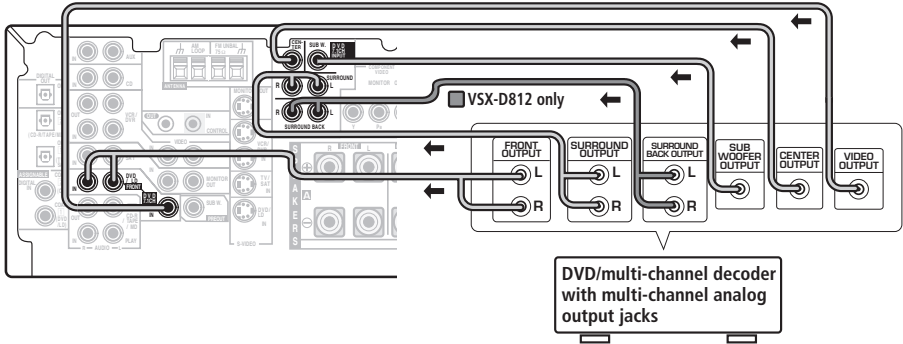

* The illustration shows the VSX-D812, but connections for the VSX-D712 are the same.

Note

- The multi-channel input can only be used when **DVD 5.1 ch** (or **DVD 7.1 ch**) is selected (see page 43).
- If the component you are connecting (to the VSX-D812) only has one surround back channel output, change the Surround back channel input setting (page 50) to **SB 1ch IN**.

Connecting video components

Connect your video components to the jacks as shown in the illustration. With digital video components (like a DVD player), you must use the connections shown on this page for the video signal, but in order to hear a digital source (like a DVD) you should hook up the audio to a digital input (see page 16). It is also a good idea to hook up your digital components with analog audio connections (see page 17).

For better quality video, you can hook up using the component video jacks or the S-video jacks (quality descends in this order) on the rear of the receiver instead of the regular video jacks. Make sure they are connected to the video component using the same kind of connection.

When connecting your equipment, always make sure the power is turned off and the power cord is disconnected from the AC outlet.

- The arrows indicate the direction of the signal.

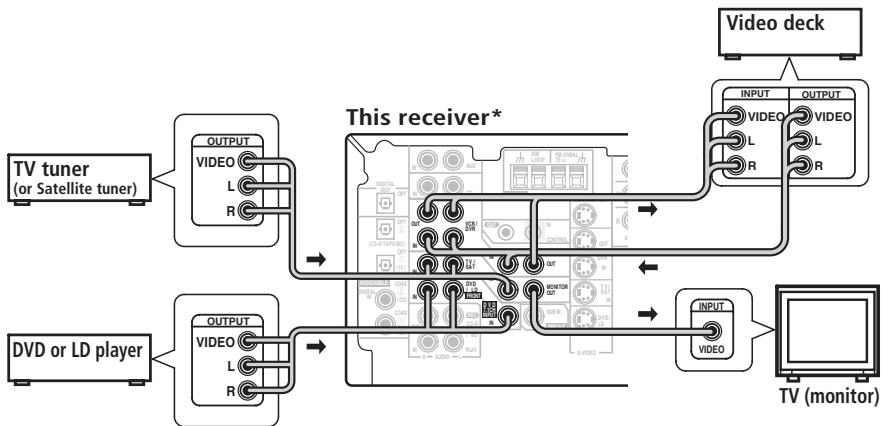

* The illustration shows the VSX-D812, but connections for the VSX-D712 are the same.

Connecting to the front panel video terminal

Front video connections are accessed via the front panel using the **VIDEO** button. There are standard audio/video jacks as well as an S-video jack. Hook them up the same way you made the rear panel connections.

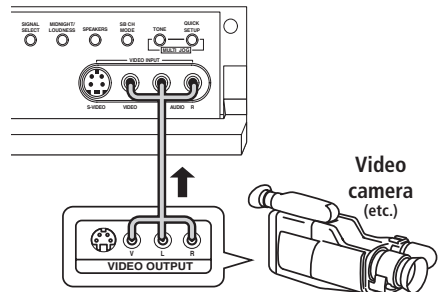

Connecting antennas

Connect the AM loop antenna and the FM wire antenna as shown below. To improve reception and sound quality, connect external antennas (see *Using external antennas* below). Always make sure that the receiver is switched off and unplugged from the wall outlet before making or changing any connections.

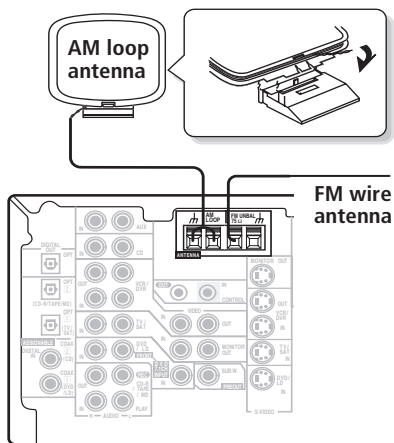

Antenna snap connectors

Twist the exposed wire strands together and insert into the hole, then snap the connector shut.

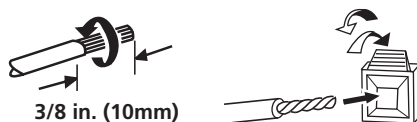

Using external antennas

To improve FM reception

Connect an external fm antenna.

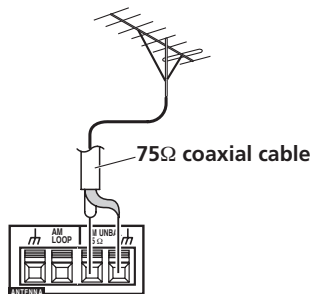

FM wire antenna

Connect the FM wire antenna and fully extend vertically along a window frame or another suitable place that gives good reception.

AM loop antenna

Assemble the antenna and connect to the receiver. Attach (if necessary) and face in the direction that gives the best reception.

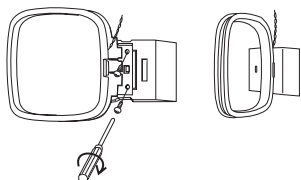

To improve AM reception

Connect a 15-18 feet length of vinyl-coated wire to the AM antenna terminal without disconnecting the supplied AM loop antenna. For the best possible reception, suspend horizontally outdoors.

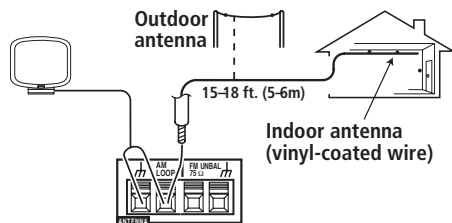

Connecting the speakers (VSX-D712)

A complete setup of six speakers (including the subwoofer) is shown below, but everyone's home setup will vary. Simply connect the speakers you have in the manner shown below. The receiver will work with just two stereo speakers (the front speakers in the diagram) but using at least three speakers is recommended, and a complete setup is best. If you're not using a subwoofer, change the front speaker setting (see *Speaker setting* on page 45) to large.

Make sure you connect the speaker on the right to the right terminal and the speaker on the left to the left terminal. Also make sure the positive and negative (+/−) terminals on the receiver match those on the speakers.

Be sure to complete all connections before connecting this unit to the AC power source.



Important

- Use speakers with a nominal impedance of 8 Ω to 16 Ω.

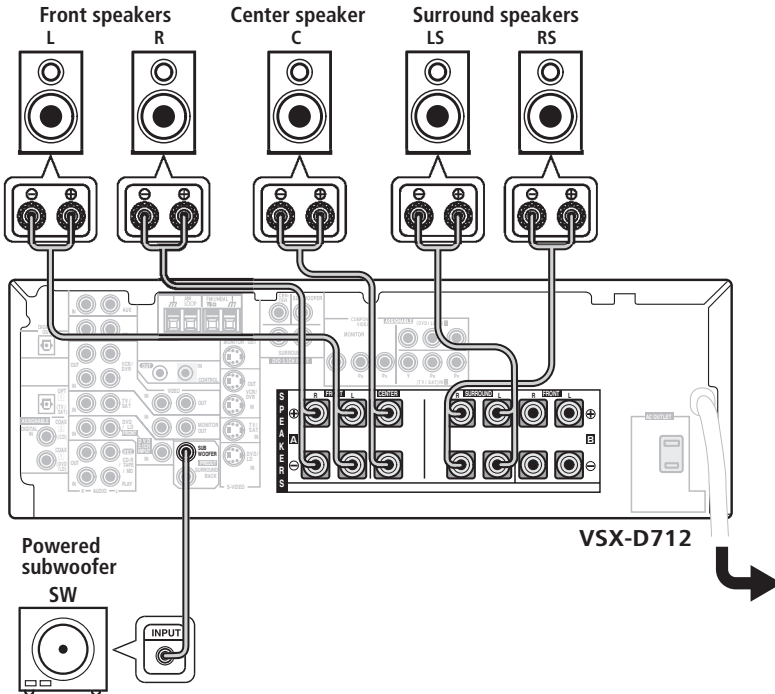

Connecting the speakers (VSX-D812)

A complete setup of eight speakers (including the subwoofer) is shown below, but everyone's home setup will vary. Simply connect the speakers you have in the manner shown below. The receiver will work with just two stereo speakers (the front speakers in the diagram) but using at least three speakers is recommended, and a complete setup is best for surround sound. If you're not using a subwoofer, change the front speaker setting (see *Speaker setting* on page 45) to large.

Make sure you connect the speaker on the right to the right terminal and the speaker on the left to the left terminal. Also make sure the positive and negative (+/-) terminals on the receiver match those on the speakers.

Be sure to complete all connections before connecting this unit to the AC power source.

 **Important**

- Use speakers with a nominal impedance of 8 Ω to 16 Ω.

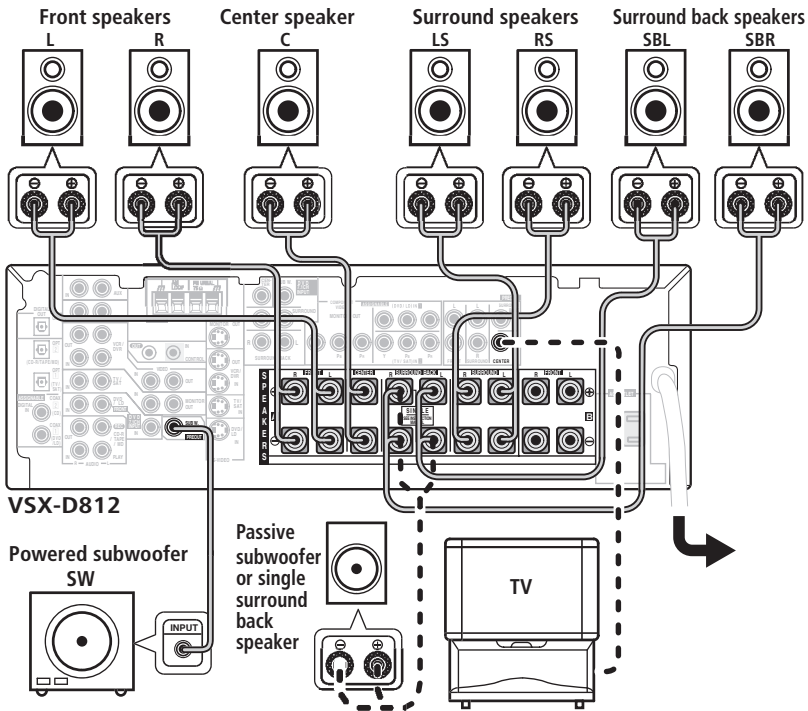

 **Note**

- When using the speaker on your TV as the center speaker (**C**), connect the **CENTER PREOUT** jack on this unit to the audio input jack on your TV. In this case the center speaker shown is unnecessary.
- If you are using only one surround back speaker, connect the positive wire to the right channel (+) terminal, and the negative wire to the left channel (-) terminal (see illustration on page 12).
- If you select subwoofer (**SB SW**) in the *Surround back speaker setting* on page 46 you can hook up a subwoofer instead of speakers to the surround back speaker terminals. Connect the positive wire to the right channel (+) terminal, and the negative wire to the left channel (-) terminal (see illustration on page 12).

 **Note**

- The speaker terminals also accept single banana plugs. (Refer to speaker manual for details.)

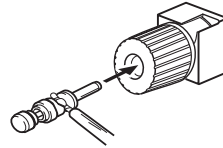

Speaker terminals

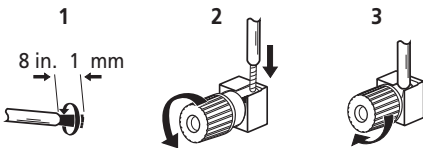

1 Twist exposed wire strands together.

2 Loosen speaker terminal and insert exposed wire.

Make sure that all the bare speaker wire is twisted together and inserted fully into the speaker terminal. If any of the bare speaker wire is touching the back panel when you switch the unit on, the power may cut off as a safety measure. Use good quality speaker wire to connect the speakers to the receiver.

3 Tighten terminal.

A and B speaker systems

The receiver has two speaker systems: A and B. A is the main system supporting the full speaker setup. If you switch on both A and B speaker systems, only the front speakers and the (active) subwoofer will be audible. No sound will come from the center, surround, or surround back speakers, but multi-channel sources will be down-mixed to the active speakers so no sound will be lost. Similarly, if you choose just the B system you'll only hear the front speakers connected to the B system and multi channel sources will be down-mixed to these two speakers.

- **Press the **SPEAKERS** button on the front panel to switch between speaker systems (A, B or both).**

Hints on speaker placement

Speakers are usually designed with a particular placement in mind. Some are designed to be floorstanding, while others should be placed on stands to sound their best. Some should be placed near a wall; others should be placed away from walls. We have provided a few tips on getting the best sound from your speakers (following), but you should also follow the guidelines on placement that the speaker manufacturer provided with your particular speakers to get the most out of them.

- Place the front left and right speakers at equal distances from the TV.
- When placing speakers near the TV, we recommend using magnetically shielded speakers to prevent possible interference, such as discoloration of the picture when the TV is switched on. If you do not have magnetically shielded speakers and notice discoloration of the TV picture, move the speakers farther away from the TV.
- Place the center speaker above or below the TV so that the sound of the center channel is localized at the TV screen.
- If possible, place the surround speakers slightly above ear level.
- Try not to place the surround speakers further away from the listening position than the front and center speakers. Doing so can weaken the surround sound effect.
- To achieve the best possible surround sound, install your speakers as shown below. Be sure all speakers are installed securely to prevent accidents and improve sound quality.

Caution

- If you choose to install the center speaker on top of the TV, be sure to secure it with putty, or by other suitable means, to reduce the risk of damage or injury resulting from the speaker falling from the TV in the event of external shocks such as earthquakes.

Overhead view of 5.1 channel speaker setup

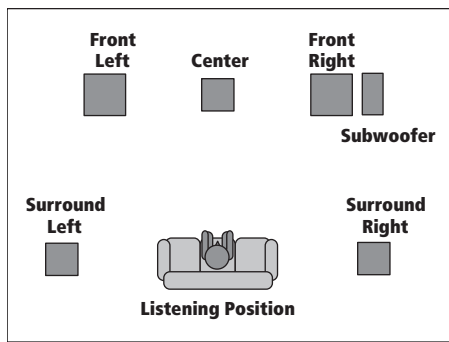

3-D view of 5.1 channel speaker setup

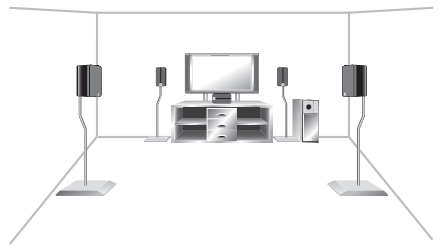

Overhead view of 6.1 channel speaker setup

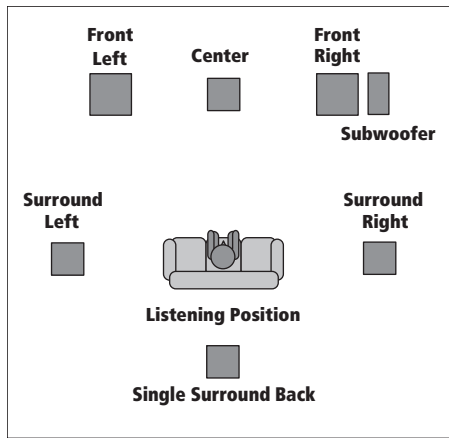

3-D view of 6.1 channel speaker setup



Overhead view of 7.1 channel speaker setup

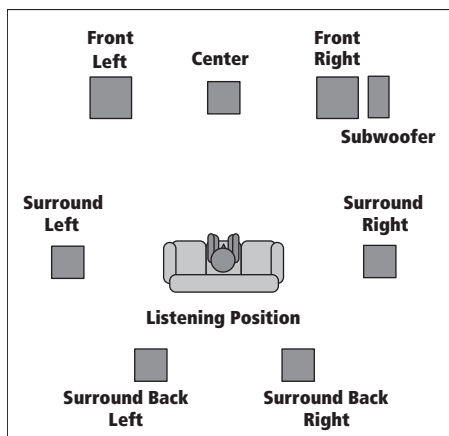

3-D view of 7.1 channel speaker setup



Connecting additional amplifiers

This receiver has more than sufficient power for any home use, however it is possible to add additional amplifiers to every channel on the VSX-D812 or the surround back channel of the VSX-D712. Make the connections shown below to add amplifiers to power your speakers. Always make sure that the receiver is switched off and unplugged from the wall outlet before making or changing any connections.

- The arrows indicate the direction of the audio signal.

VSX-D712

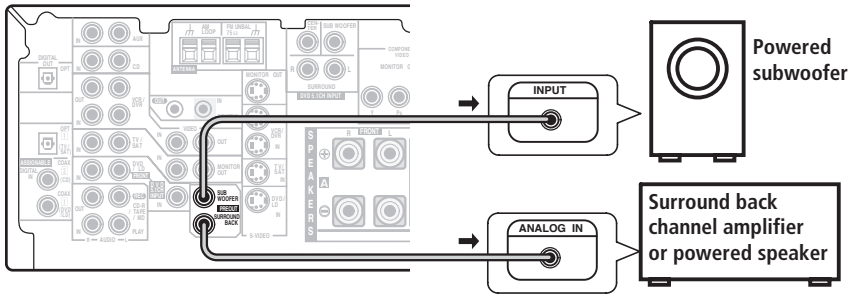

VSX-D812

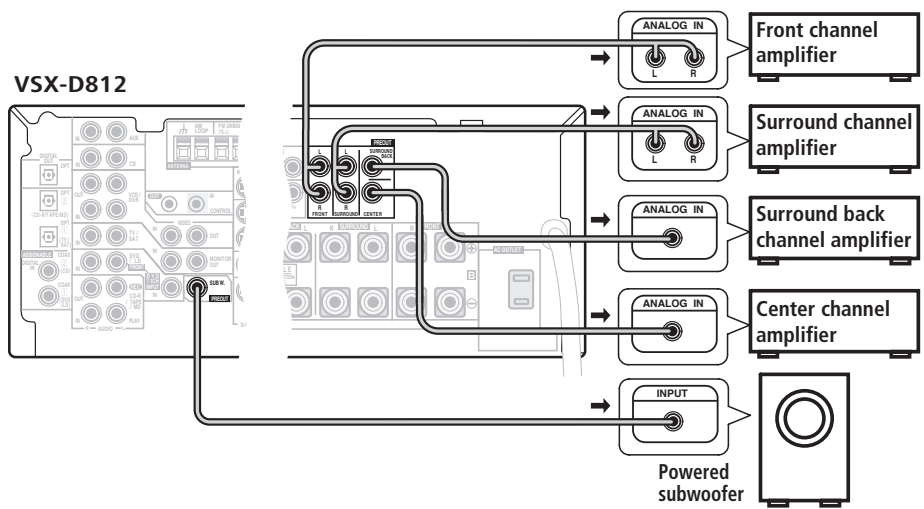

Note

- To hear sound only from the pre-outs, disconnect any speakers that are connected directly to the receiver.

- If you're not using a subwoofer, change the front speaker setting (see *Speaker setting* on page 45) to large.
- *VSX-D712 only* – If you connect to a surround back speaker, make sure the *Surround back speaker setting* on page 46 is switched on and set to the proper speaker size.

Note

- Make sure no exposed speaker wire is touching the rear panel, this may cause the receiver to turn off automatically.
- This unit should be disconnected by removing the power plug from the wall socket when not in regular use (ex. when on vacation).

AC outlet

Power supplied through this outlet is turned on and off by the receiver's power switch. Total electrical power consumption of connected equipment should not exceed 100 W (0.8 A).

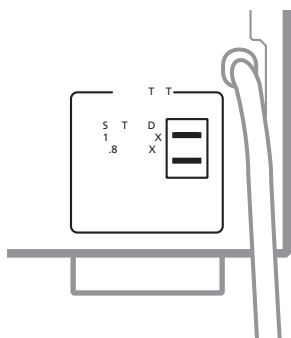

Power cord caution

Handle the power cord by the plug. Do not pull out the plug by tugging the cord and never touch the power cord when your hands are wet as this could cause a short circuit or an electric shock. Do not place the unit, a piece of furniture, etc., on the power cord, or pinch the cord. Never make a knot in the cord or tie it with other cords. The power cords should be routed such that they are not likely to be stepped on. A damaged power cord can cause a fire or give you an electrical shock. Check the power cord once in a while. When you find it damaged, ask your nearest Pioneer authorized service center or your dealer for a replacement.

Caution

- Do not connect a monitor, TV set, heater, or similar appliance to this unit's AC outlet.
- Do not connect appliances with high power consumption to the AC outlet in order to avoid overheating and fire risk. This can also cause the receiver to malfunction.

Operating other Pioneer components

By connecting a control cord (optional), you can point the remote controls of other Pioneer components at the receiver's remote sensor. The remote control signals are received by the remote sensor of this unit, and sent to the other devices via the **CONTROL OUT** terminals on the receiver.

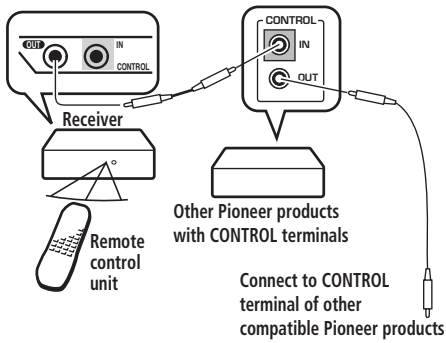

Chapter 4: Controls and displays

Front panel

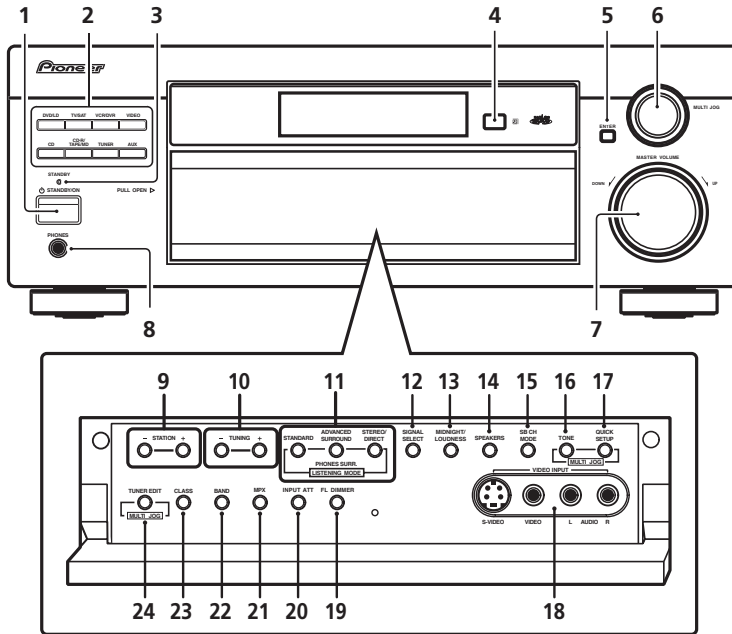

1 **STANDBY/ON**

Switches the receiver between on and standby.

2 **Input select buttons**

Press to select an input source.

3 **STANDBY indicator**

Lights when the receiver is in standby mode.

4 **Remote sensor**

Receives the signals from the remote control.

5 **ENTER**

6 **MULTI JOG dial**

The **MULTI JOG** dial performs a number of tasks. Use it to select options after pressing **TONE**, **QUICK SETUP** or **TUNER EDIT**.

7 **MASTER VOLUME**

8 **PHONES jack**

Use to connect headphones. When the headphones are connected, there is no sound output from the speakers.

9 STATION +/- buttons

Selects station presets when using the tuner (page 55).

10 TUNING +/- buttons

Selects the frequency when using the tuner (page 54).

11 LISTENING MODE buttons**STANDARD**

Press for Standard decoding and to switch between the various Pro Logic II and Neo:6 options (page 38).

ADVANCED SURROUND

Use to switch between the various surround modes (page 39).

STEREO/DIRECT

Switches between direct and stereo playback. Direct playback bypasses the tone controls and channel levels for the most accurate reproduction of a source (page 39).

12 SIGNAL SELECT

Use to select an input signal (page 37).

13 MIDNIGHT/LOUDNESS

Use Midnight when listening to movie soundtracks at low volume. Use Loudness to boost the bass and treble at low volume (page 42).

14 SPEAKERS

Use to cycle through the speaker system:
A → B → A+B (page 23)

15 SB CH MODE

Selects the surround back channel mode (page 40) and the Virtual Surround Back (VSB) mode (page 41).

16 TONE

Press this button to access the bass and treble controls, which you can then adjust with the **MULTI JOG** dial (page 42).

17 QUICK SETUP

See *Using the Quick Setup* on page 13.

18 VIDEO INPUT

See *Connecting to the front panel video terminal* on page 19.

19 FL DIMMER

Use this button to make the fluorescent display (FL) dimmer or brighter.

20 INPUT ATT

Use to attenuate (lower) the level of an analog input signal to prevent distortion.

21 MPX

Press to receive a radio broadcast in mono (page 54).

22 BAND

Switches between AM and FM radio bands (page 54).

23 CLASS

Switches between the three banks (classes) of station presets (page 55).

24 TUNER EDIT

Press to memorize and name a station for recall (page 55).

Display

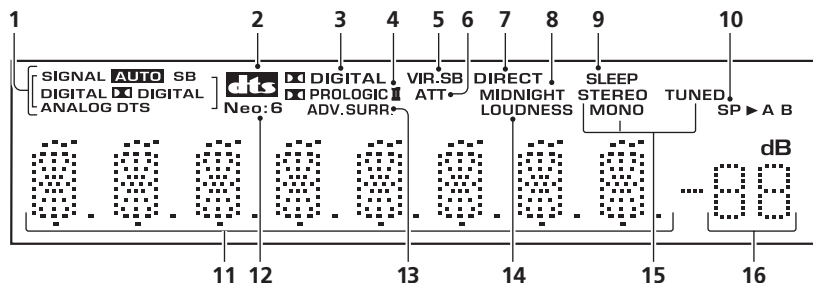

1 SIGNAL SELECT indicators

Lights to indicate the type of input signal assigned for the current component:

AUTO

Lights when **AUTO** signal select is on.

SB

Depending on the source, this lights when a signal with surround back channel encoding is detected.

DIGITAL

Lights when a digital audio signal is detected.

DIGITAL

Lights when a Dolby Digital encoded signal is detected.

ANALOG

Lights when an analog signal is detected.

DTS

Lights when a source with DTS encoded audio signals is detected.

2 DTS

When the **STANDARD** mode of the receiver is on, this lights to indicate decoding of a DTS signal.

3 **DIGITAL**

When the **STANDARD** mode of the receiver is on, this lights to indicate decoding of a Dolby Digital signal.

4 **DIGITAL**

When the (**STANDARD**) Pro Logic II mode of the receiver is on, this lights to indicate Pro Logic II decoding.

5 VIR.SB

Lights during Virtual surround back processing.

6 ATT

Lights when **INPUT ATT** is used to attenuate (reduce) the level of the analog input signal.

7 DIRECT

Lights when source direct playback is in use. Direct playback bypasses the tone controls and channel levels for the most accurate reproduction of a source.

8 MIDNIGHT

Lights during Midnight listening.

9 SLEEP

Lights when the receiver is in sleep mode.

10 Speaker indicator

Shows the speaker system currently in use.

11 Character display

12 Neo:6

When the (**STANDARD**) NEO:6 mode of the receiver is on, this lights to indicate NEO:6 processing.

13 ADV.SURR. (Advanced Surround)

Lights when one of the Advanced Surround modes has been selected.

14 LOUDNESS

Lights when **LOUDNESS** has been selected.

15 TUNER indicators**STEREO**

Lights when a stereo FM broadcast is being received in auto stereo mode.

MONO

Lights when the mono mode is set using the **MPX** button.

TUNED

Lights when a broadcast is being received.

16 Master volume level

Shows the overall volume level. **---dB** indicates the minimum level, and **- 0 dB** indicates the maximum level.

Depending on your level settings for each channel, the maximum volume can range between -10 dB and -0 dB.

Remote control

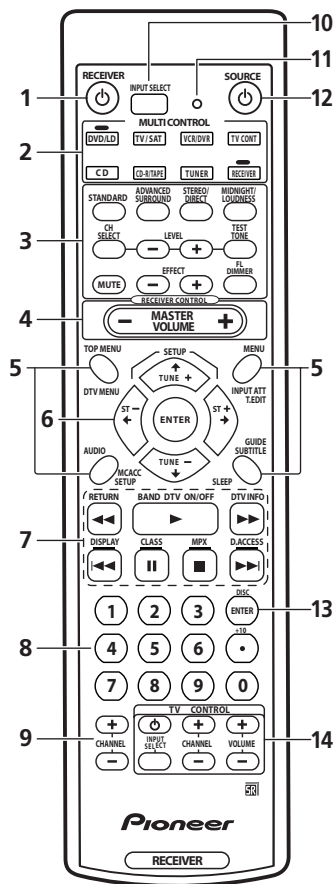

1 RECEIVER

This switches between standby and on for this receiver.

2 MULTI CONTROL buttons

Press to select control of other components (see *Controlling the rest of your system* on page 58).

RECEIVER

Switches the remote to control the receiver (used to select the features such as **SLEEP**, **MCACC SETUP**, etc). Also use this button to set up surround sound (page 44, page 51).

3 RECEIVER CONTROL buttons

STANDARD

Press for Standard decoding and to switch between the various Pro Logic II and Neo:6 options (page 38).

ADVANCED SURROUND

Use to switch between the various surround modes (page 39).

STEREO/DIRECT

Switches between direct and stereo playback. Direct playback bypasses the tone controls and channel levels for the most accurate reproduction of a source (page 39).

MIDNIGHT/LOUDNESS

Switches to Midnight or Loudness listening (page 42).

CH SELECT

Selects a speaker when setting up the surround sound of the receiver (page 52).

LEVEL +/-

Adjusts the levels of the surround sound of the receiver (page 52).

TEST TONE

Sounds the test tone when setting up the surround sound of the receiver (page 52).

MUTE

Mutes the sound (or restores the sound if it has been muted).

EFFECT +/-

Adds or subtracts the amount of effect with different advanced surround modes (page 39).

FL DIMMER

Dims or brightens the display.

4 MASTER VOLUME +/-

Use to set the listening volume.

5 Receiver and component control buttons *(Press the corresponding **MULTI CONTROL** button first to access).*

These controls function according to the component you've selected.

TOP MENU

Displays the disc 'top' menu of a DVD.

DTV MENU

Displays menus on a digital TV.

AUDIO

Changes the audio language or channel with DVD discs.

MCACC SETUP

Use to setup your speaker system using the multi-channel acoustic calibration system.

MENU

Displays the disc menu of DVD-Video discs. It also displays TV and DTV menus.

INPUT ATT

Attenuates (lowers) the level of an analog input signal to prevent distortion.

T.EDIT

Use to memorize and name a station for recall using the **STATION +/-** buttons (page 55).

GUIDE

Displays the guides on a digital TV.

SUBTITLE

Displays/changes the subtitles included in multilingual DVD-Video discs.

SLEEP

Use to put the receiver in sleep mode and select the amount of time before the receiver turns off.

6 ⇐⇒⇩⇧ (TUNE +/-, ST +/-) /ENTER

Use the arrow buttons when setting up your surround sound system (see page 44). Also used to control DVD menus/options and for deck 1 of a double cassette deck player. Use the **TUNE +/-** buttons to find radio frequencies and use **ST +/-** to find preset stations (page 55).

7 Component/Tuner control buttons

The main buttons (▶, ■, etc.) are used to control a component after you have selected it using the **MULTI CONTROL** buttons. The tuner/DTV controls above these buttons can be accessed after you have selected the corresponding **MULTI CONTROL** button (**TUNER** or **TV/SAT** (when connected to DTV)).

RETURN

Returns to the last screen selected when using a digital TV tuner.

BAND DTV ON/OFF

Switches between the tuner AM and FM bands (page 54). Also switches a digital TV on/off (page 60).

DTV INFO

Use to bring up information screens on a digital TV.

DISPLAY

Use to switch the display between the station preset name and the frequency for the tuner.

CLASS

Switches between the three banks (classes) of radio station presets (page 55).

MPX

Switches between stereo and mono reception of FM broadcasts. If the signal is weak then switching to mono will improve the sound quality (page 54).

D.ACCESS

After pressing, you can access a radio station directly using the number buttons (page 54).

8 Number buttons

Use the number buttons to directly select a radio frequency (page 54) or the tracks on a CD, DVD, etc.

9 CHANNEL +/-

Use to select channels when using a VCR, DVR, etc. Also use to skip tracks backward or forward on CDs, DVDs, etc.

10 INPUT SELECT

Use to select the input source.

11 LED

This lights when a command is sent from the remote control.

12 SOURCE

Press to turn on/off other components connected to the receiver.

13 DISC (ENTER)

The button's use depends on the component selected. It can be used to enter commands for TV or DTV, and can also be used to select a disc in a multi-CD player.

14 TV CONTROL buttons

These buttons are dedicated to control the TV assigned to the **TV CONT** button. Thus if you only have one TV to hook up to this system assign it to the **TV CONT MULTI CONTROL** button. If you have two TVs, assign the main TV to the **TV CONT** button.



Use to turn on/off the power of the TV.

(TV CONTROL) INPUT SELECT

Use select the TV function.

CHANNEL +/-

Use to select channels.

VOLUME +/-

Use to adjust the volume on your TV.

Chapter 5: Playing sources

Introduction to Sound Modes

There are three basic sound options: Stereo/Direct (**STEREO/DIRECT**), Standard (**STANDARD**) or Advanced Surround (**ADVANCED SURROUND**).

Stereo/Direct

When you select **STEREO** or **DIRECT**, you will hear the source through just the front left and right speakers (and possibly your subwoofer depending on your speaker settings). Dolby Digital and DTS multichannel sources are downmixed to stereo.

In **STEREO**, you'll hear the audio with your surround settings and you can still use the Midnight, Loudness, and Tone control functions.

With **DIRECT**, you will bypass all effects and surround settings so that the audio remains as close to the source audio signal as possible.



Note

- If you switch on Midnight listening, Loudness, or the Tone controls when **DIRECT** is selected, the receiver automatically switches to **STEREO**.

Standard mode

The Standard mode can be used to decode Dolby Digital, DTS, and Dolby Surround sources.

The other surround sound options (next column) can add multi-channel sound to regular stereo sources.

You can identify Dolby Digital software by the



marks. Most Dolby Surround software is marked **DOLBY SURROUND**, but unmarked software may also incorporate Dolby Surround. Depending on the source and the sound mode you have selected, you may not get sound from the surround back speakers in your setup. For more on this, refer to *Using the Virtual Surround Back mode (VSB)* on page 41 and *Using the Surround Back Channel (SB CH)* on page 40.

Choose one of the following to add depth to a 2 channel source:

Pro Logic II Movie (MOVIE)

This mode gives 5.1 channel surround sound. It is suitable for movies, especially those recorded in Dolby Surround. The channel separation and movement of surround effects is comparable to Dolby Digital 5.1.

Pro Logic II Music (MUSIC)

This mode gives 5.1 channel surround sound and is suitable for music. The surround effect is more enveloping than Pro Logic II Movie.

Pro Logic (PROLOGIC)

This mode gives 4.1 channel surround sound. It is less sensitive to the quality of the source material, so may be useful when Pro Logic II Movie/ Music modes don't give good results.

Neo:6 Cinema (CINEMA)

This mode gives 6.1 channel surround sound and is suitable for movies. The Neo:6 Cinema mode delivers good channel separation for movie soundtracks.

Neo:6 Music (MUSIC)

This mode gives 6.1 channel surround sound and is suitable for music. The Neo:6 Music mode plays the stereo source as is through the front left/right speakers, and generates a natural, ambient surround and center sound.

Advanced Surround modes

These are designed to be used with multi-channel surround sound audio/visual sources (like DVDs and LDs). Most Advanced Surround modes are designed to be used with film soundtracks, but some modes are also suited for music sources. Try different settings with various soundtracks to see which you like.



Note

- Depending on the source and the sound mode you have selected, you may not get sound from the surround back speakers in your setup. For more on this, refer to *Using the Virtual Surround Back mode (VSB)* on page 41 and *Using the Surround Back Channel (SB CH)* on page 40.

Advanced Movie (ADV. MOVIE)

Simulates the relaxed environment of a movie theater, and is suitable for watching movies.

Advanced Music (ADV. MUSIC)

Simulates the acoustic environment of a large concert hall and is suitable for music or musical sources.

TV Surround (TV. SURR.)

This mode produces surround sound for both mono and stereo TV sources. It is useful for older movies recorded with mono soundtracks.

Sports (SPORTS)

This is designed for sports programs with a lot of action, adding to the excitement by bringing background action to the forefront.

Game (GAME)

Useful when playing video games. It works especially well with sound moving from left to right in game software with a lot of movement.

Expanded (EXPANDED)

This mode is especially designed to give sound depth to stereo sources, and lets you hear two-channel (stereo) signals as simulated multi-channel surround sound. Use with Dolby Pro Logic for a stereo surround effect. You can also use with Dolby Digital sources for a wider stereo field than the **STANDARD** modes.

6-Channel Stereo (6-STEREO)

This can be selected to give multi-channel sound to a stereo source, using all of the speakers in your setup.

Phones Surround (PHONES SURROUND)

When listening through headphones, you can still get the effect of overall surround.

Choosing the input signal

- Default setting: **AUTO**

You need to hook up a component to both analog and digital inputs on the rear of the receiver to select between input signals.

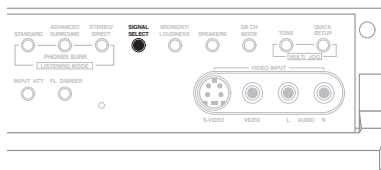

- Press **SIGNAL SELECT** (front panel) to select the input signal corresponding to the source component.

Each press cycles through the options as follows:



The **AUTO** setting automatically switches to **DIGITAL** if a digital source is detected, otherwise the signal select will be **ANALOG**.

DVD 5.1ch (VSX-D712) and **DVD 7.1ch** (VSX-D812) will only appear when **DVD/LD** is selected.

When set to **DIGITAL** or **AUTO**, **DIGITAL** lights when a Dolby Digital signal is input, and **DTS** lights when a DTS signal is input.

Note

- This receiver can only play back Dolby Digital, PCM (32kHz–96 kHz) and DTS digital signal formats (however, only the VSX-D812 can decode DTS 96kHz/24 bit signal formats). With other digital signal formats, set to **ANALOG**.
- You may get digital noise when a LD or CD player compatible with DTS is playing an analog signal. To prevent noise, make the proper digital connections (page 16) and set the signal input to **DIGITAL**.
- Some DVD players don't output DTS signals. For more details, refer to the instruction manual supplied with your DVD player.

Listening to multi-channel playback

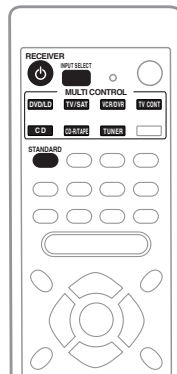

- 1 Switch on the playback component.
- 2 Turn on the power of the receiver.
- 3 Select the source you want to playback.

Use the **MULTI CONTROL** buttons (or **INPUT SELECT**).

4 Press STANDARD.

If the source is Dolby Digital, DTS, or Dolby Surround encoded, the proper decoding format will automatically be selected and shows in the display.

If you are listening to a two channel source, each press changes the display as follows:

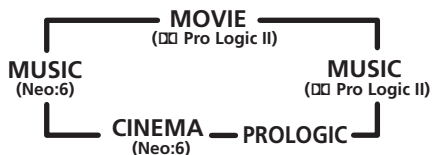

Refer to page 36 for more details about each mode.

Playing sources

5 Start playback of the component you selected in step 1.



Note

- You can't use the **STANDARD** mode with 96kHz PCM or DTS 96kHz/24-bit stereo sources.

Using Stereo/Direct

When you select **STEREO** or **DIRECT**, you will hear the source through just the front left and right speakers (and possibly your subwoofer depending on your speaker settings). Dolby Digital and DTS multichannel sources are downmixed to stereo. See page 36 for more on these modes.

- Press **STEREO/DIRECT** repeatedly to switch between the two options.



Note

- If you switch on Midnight listening, Loudness, or the Tone controls when **DIRECT** is selected, the receiver automatically switches to **STEREO**.

Using Advanced Surround

When you select one of the Advanced Surround options, Dolby Pro Logic, Dolby Digital and DTS decoding is done automatically corresponding to the input signal. Use Advanced Surround to add effects to the surround sound.

- Press **ADVANCED SURROUND** repeatedly to cycle the sound options.

Each press changes the display as follows:

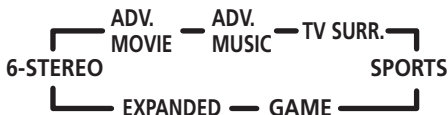

Refer to page 37 for more details about each surround effect.



Note

- If you press **ADVANCED SURROUND** when the headphones are connected, the **PHONES SURROUND** mode will automatically be selected.
- You can't use the Advanced Surround listening modes with 96kHz PCM or DTS 96kHz/24 bit signal formats.



Tip

- The Advanced Surround effects can be adjusted in the range of 10 to 90 by pressing **EFFECT +/-**. The effect level can be set for each Advanced Surround mode. The Standard (**STANDARD**) mode cannot be changed.

Using the Surround Back Channel (SB CH)

- Default setting: **SB ON** (VSX-D812), **SB OFF** (VSX-D712)

You can have the receiver automatically switch to Dolby Digital EX or DTS-ES decoding for 6.1 encoded sources (**SB AUTO**), or you can choose to listen to other kinds of sources (for example, 5.1 encoded material) with 6.1 encoding (**SB ON**). With 5.1 encoded sources, a surround back channel will be generated, but the material may sound better in the 5.1 format for which it was originally encoded, in which case you can simply switch the surround back channel off (**SB OFF**).

The table indicates when you will hear the surround back channel.

- Press **SB CH MODE** (front panel) repeatedly to cycle the surround back channel options.

Each press cycles through the options as follows:

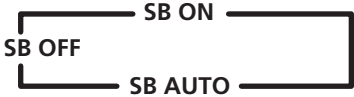

Note

- You can't use the surround back channel if the *Surround back speaker setting* on page 46 is set to **SB *** or **SB SW** (VSX-D812 only).
- You can't hear the surround back channel with DTS 96kHz/24 bit sources.

Type of source	SB CH MODE	STANDARD			ADVANCED SURROUND
		STANDARD decoding	MOVIE/MUSIC/ PROLOGIC	NEO:6 CINEMA/ NEO:6 MUSIC	All modes
DTS-ES/Dolby Digital Matrix encoded multi-channel sources with 6.1 surround	ON	√			√
	AUTO	√			√
Dolby Digital/DTS encoded multi-channel sources	ON	√			√
	AUTO				√
Dolby Digital/DTS encoded stereo sources, Stereo sources	ON		√	√	√
	AUTO			√	√
Analog 2-channel (stereo) source	ON		√	√	√
	AUTO			√	√

Playing sources

Using the Virtual Surround Back mode (VSB)

Selecting this mode allows you to hear a virtual back channel through your surround speakers. For example, you can choose to listen to sources with no surround back channel information (for example, 5.1 encoded material) with emulated 6.1 encoding (**VSB ON**). Sometimes the material may sound better in the 5.1 format for which it was originally encoded. In this case you can have the receiver only apply this effect to 6.1 encoded sources like Dolby Digital EX or DTS-ES (**VSB AUTO**), or you can simply switch it off (**VSB OFF**).

The table indicates when you will hear the virtual surround back channel.

- Press **SB CH MODE** (front panel) repeatedly to cycle the virtual surround back channel options.

Each press cycles through the options as follows:



Note

- You can't use the Virtual Surround Back mode if the *Speaker setting* on page 45 is set to **S***.
- You can only use the Virtual Surround Back mode if the *Surround back speaker setting* on page 46 is set to **SB *** or **SB SW** (VSX-D812 only).
- You can't adjust the surround back channel level when you're listening to the virtual surround back channel.

Type of source	Virtual Surround Back mode	STANDARD			ADVANCED SURROUND
		STANDARD decoding	MOVIE/MUSIC/PROLOGIC	NEO:6 CINEMA/NEO:6 MUSIC	All modes
DTS-ES/Dolby Digital Matrix encoded multi-channel sources with 6.1 surround	ON	√			√
	AUTO	√			√
Dolby Digital/DTS encoded multi-channel sources	ON	√			√
	AUTO				√
Dolby Digital/DTS encoded stereo sources, Stereo sources	ON		√	√	√
	AUTO			√	√
Analog 2-channel (stereo) source	ON		√	√	√
	AUTO			√	√

Using Midnight and Loudness listening

The Midnight listening feature allows you to hear effective surround sound of movies at low volume levels. The effect automatically adjusts according to the volume at which you're listening.

The Loudness listening feature can be used to get good bass and treble from music sources at low volume levels.

- Press **MIDNIGHT/LOUDNESS**.

Each press cycles through the effects as follows:



Note

- You can't use **MIDNIGHT/LOUDNESS** when **DVD 5.1 ch/DVD 7.1 ch** has been selected, or when listening to a DTS 96kHz/24 bit source.

Using the tone controls

Depending on what you are listening to, you may want to adjust the bass or treble using the front panel tone control.

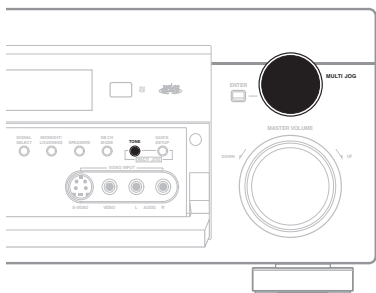

- 1 Press **TONE** to select the frequency you want to adjust.

Each press switches between **BASS** and **TREBLE**.

- 2 Use the **MULTI JOG** dial to change the amount of bass or treble as necessary.

Wait about five seconds for your changes to be input automatically.

Note

- You can only use the tone controls when **STEREO/DIRECT** is selected. **DIRECT** will switch to **STEREO** when the tone controls are used.
- The tone controls affect **SPEAKER A** only. They can't be used when **SPEAKER A** is switched off.

Playing other sources

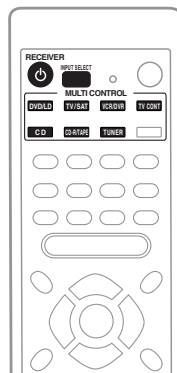

- 1 Turn on the power of the playback component.
- 2 Turn on the power of the receiver.
- 3 Select the source you want to playback.

Use the **MULTI CONTROL** buttons (or **INPUT SELECT**).

4 Start playback of the component you selected in step 1.

Selecting the multi-channel analog inputs

If you have connected a decoder or a DVD player with multi-channel analog outputs to this receiver (page 18), you must select the analog multi-channel inputs for surround sound playback.

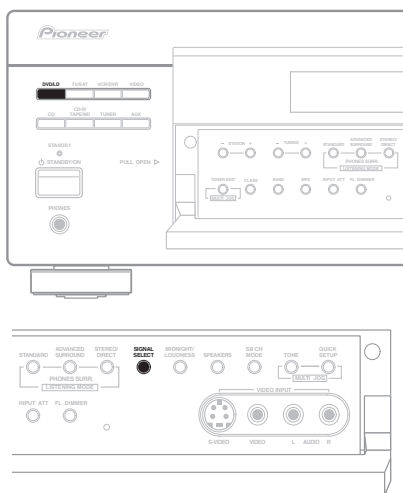

1 Press DVD/LD.

2 Press **SIGNAL SELECT** repeatedly to select DVD 5.1ch/DVD 7.1ch.

To cancel playback from the multi-channel inputs, use the **SIGNAL SELECT** button to select a different input signal.



Note

- When playback from the multi-channel inputs is selected, you can't use the **INPUT ATT**, **TONE**, and **MIDNIGHT/LOUDNESS** buttons, as well as the **STANDARD**, **ADVANCED SURROUND**, and **STEREO/DIRECT** sound modes.
- When playback from the multi-channel inputs is selected, only the volume and channel levels can be set.

Using the sleep timer

The sleep timer switches the receiver into standby after a specified amount of time so you can fall asleep without worrying about the receiver being left on all night. Use the remote control to set the sleep timer.

1 Press **RECEIVER**.

2 Press **SLEEP** repeatedly to set the sleep time.

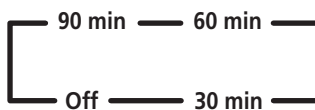

Tip

- You can check the remaining sleep time at any time by pressing **SLEEP** once. Pressing repeatedly will cycle through the sleep options again.
- You can also switch off the sleep timer simply by switching off the receiver.

Chapter 6: Setting up the receiver

Choosing your receiver setup

To ensure the best possible surround sound, be sure to complete the following set up operations. This is particularly important when using DTS and Dolby surround. You only need to make these settings once (unless you change the placement of your current speaker system or add new speakers, etc.). Refer to the following pages for details on each of the settings.



- If you are using the Pioneer S-FCRW230/730 speaker system, make sure the *Subwoofer setting* is set to **YES** and the *Speaker setting* is set to **FS-CS-SS**. You'll also have to change the *Crossover frequency setting* to **200Hz**.

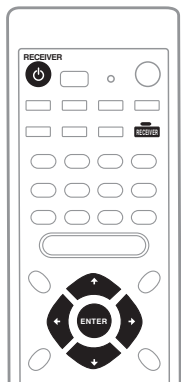

1 Press RECEIVER to turn the power on.
The **STANDBY** indicator goes out.

2 Press RECEIVER.

3 Use ← or → to choose the option you want to adjust.

It will be easiest to adjust each of the settings in turn, following the order below (and on the following pages). The current setting is shown for each option as you cycle through the display.

Speaker setting (page 45)
Specify the number and type of speakers you have connected.

Surround back speaker setting (page 46)
Specify your surround back speaker/surround back subwoofer setup.

Subwoofer setting (page 46)
Specify how the subwoofer is used.

Crossover frequency setting (page 46)
Determine which frequencies will be sent to the subwoofer (or large speakers).

LFE attenuator setting (page 47)
Choose the attenuator level for the LFE channel.

Front left speaker distance setting (page 47)
Specify the distance from your listening position to your front left speaker.

Center speaker distance setting (page 47)
Specify the distance from your listening position to your center speaker.

Front right speaker distance setting (page 48)
Specify the distance from your listening position to your front right speaker.

Surround right speaker distance setting (page 48)

Specify the distance from your listening position to your surround right speaker.

Surround back speaker distance setting (page 48)

Specify the distance from your listening position to your surround back speakers.

Surround left speaker distance setting (page 48)

Specify the distance from your listening position to your surround left speaker.

Subwoofer distance setting (page 48)

Specify the distance from your listening position to your subwoofer.

Dynamic range control setting (page 49)

Compress the dynamic range of the sound track.

Dual mono setting (page 49)

Isolate one channel when listening to discs with dual mono encoding.

Component video input settings (page 49)

Specify the components to be assigned to the component video inputs (below).

- Component video 1 input setting
- Component video 2 input setting

Surround back channel input setting

(VSX-D812 only) (page 49)

Specify the number of surround back inputs you have connected.

Digital input settings (page 50)

Specify the components to be assigned to the digital inputs (below).

- Coaxial digital input 1 setting
- Coaxial digital input 2 setting
- Optical digital input 1 setting
- Optical digital input 2 setting *(VSX-D812 only)*

4 Use \uparrow or \downarrow to adjust the setting.

The setting is entered automatically.

5 Repeat steps 3 and 4 to adjust other setup options.

6 When you're done, press ENTER to exit.



Note

- The setting display is automatically exited after 3 minutes of inactivity.

Speaker setting

- Default setting: **FL-CS-SS** (If a subwoofer is detected when you turn the receiver on, the default is **FS-CS-SS**.)

You must let the receiver know how many speakers you have, and how big they are. The size you choose (large or small) determines how much bass is sent from the receiver to the speakers.

In the display, **F**, **C**, and **S** refer to front, center, and surround speakers respectively. Speaker size is denoted as **L** for large speakers, **S** for small speakers, and * (asterisk) if no speaker is connected.



Note

- If the cone size (diameter) of the speaker is larger than 5 inches, set the speaker size to **L**.
- If you're not using a subwoofer, we recommend setting the front speakers to **L**.
- **Cycle through the available choices using \uparrow or \downarrow and choose a configuration that matches your speaker setup.**

Setting up the receiver

One of the following configurations should match your setup:

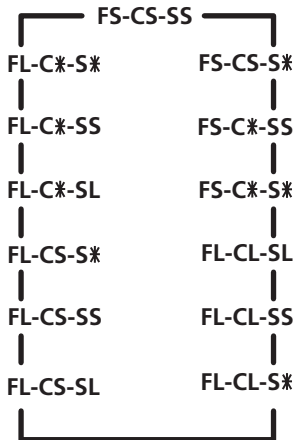

Surround back speaker setting

- Default setting: **S** (VSX-D812), ***** (VSX-D712)

You must let the receiver know if surround back speaker(s) have been connected, and how big they are. The size you choose (large or small) determines how much bass is sent from the receiver to the speakers. If you have connected a surround back subwoofer (VSX-D812), you should select the surround back subwoofer setting (**SB SW**) from the options. Choose ***** (asterisk) if no speaker is connected.

- Use **↑** or **↓** to select **SB S**, **SB ***, **SB SW** or **SB L**.

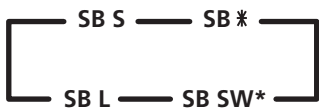

* VSX-D812 only

Note

- To select **SB L**, you must have **SL** selected in the *Speaker setting*.

Subwoofer setting

You can choose whether the subwoofer is used or not. Use the plus (**PLUS**) setting for extra bass.

- Use **↑** or **↓** to select subwoofer **YES**, **PLUS** or **NO**.

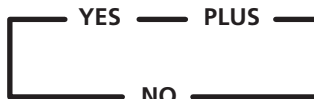

Note

- If you chose the small front speaker setting, **SW YES** is automatically set and locked.
- When you select the **PLUS** setting, you will get the bass sounds from the subwoofer even if the front speakers are set to **L**.

Crossover frequency setting

- Default setting: **100 Hz**

Crossover frequency is the point where the receiver divides the high and low sounds (the frequencies) between the speakers. Since most smaller speakers can't handle deep bass tones, you can send these sounds to the subwoofer (or if you don't have a subwoofer, the large (**L**) speakers in your system) instead of the speakers set to small (**S**) in your setup. Choose the point at which you want the frequency routed to the subwoofer (or **L** speakers).

Setting up the receiver

We recommend setting this to **200Hz** if your **S** speakers are smaller bookshelf-type speakers.

- Use \uparrow or \downarrow to specify the crossover frequency for your small speakers (100 Hz, 150 Hz or 200 Hz).

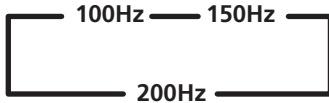

100Hz

Sends bass frequencies below 100 Hz to the subwoofer (or **L** speakers).

150Hz

Sends bass frequencies below 150 Hz to the subwoofer (or **L** speakers).

200Hz

Sends bass frequencies below 200 Hz to the subwoofer (or **L** speakers).



Note

- If all speakers (front, center, and surround) are set to **L**, the crossover frequency can't be set because there are no **S** speakers (***) appears in the display).

LFE attenuator setting

- Default setting: **0 dB**

Dolby Digital and DTS audio sources include ultra-low bass tones. Set the LFE attenuator as necessary to prevent the ultra-low bass tones from distorting the sound from the speakers.

- Use \uparrow or \downarrow to set the attenuation level (0 dB, 10 dB or ** dB(∞)).

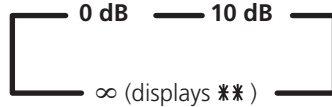

Note

- When ∞ is selected (** appears in the display), LFE cannot be heard.

Front left speaker distance setting

- Default setting: **10 ft.**

Sets the distance from the front left speaker to the listening position.

- Use \uparrow or \downarrow to set the distance of the front left speaker from the main listening position (within the range of 0.5 ft. to 45 ft.).

Center speaker distance setting

- Default setting: **10 ft.**

The center speaker is normally placed directly in the front of the listening room and closer to the listening position than the front speakers. This means that the sound from the center speaker will be heard before the front speakers. To prevent this, set the center speaker distance setting to delay the sound from the center speaker so that the sound from the front and center speakers will be heard at the same time.

Setting up the receiver

- Use **↑** or **↓** to set the distance of the center speaker from the main listening position (within the range of 0.5 ft. to 45 ft.).



Note

- When **C*** is selected in the speaker setting, the center speaker distance can't be set.

Front right speaker distance setting

- Default setting: **10 ft.**

Sets the distance from the front right speaker to the listening position.

- Use **↑** or **↓** to set the distance of the front right speaker from the main listening position (within the range of 0.5 ft. to 45 ft.).

Surround right speaker distance setting

- Default setting: **10 ft.**

You should set the distance of the surround speakers accurately to hear sounds coming from all speakers at the same time.

- Use **↑** or **↓** to set the distance of the surround right speaker from the main listening position (within the range of 0.5 ft. to 45 ft.).



Note

- When **S*** is selected in the speaker setting, the surround speaker distance can't be set.

Surround back speaker distance setting

- Default setting: **10 ft.**

You should set the distance of the surround back speakers accurately to hear sounds coming from all speakers at the same time.

- Use **↑** or **↓** to set the distance of the surround back speakers from the main listening position (within the range of 0.5 ft. to 45 ft.).



Note

- When **SB SW** (VSX-D812 only) or **SB*** is selected in the surround back speaker setting, the surround back speaker distance can't be set.

Surround left speaker distance setting

- Default setting: **10 ft.**

You should set the distance of the surround speakers accurately to hear sounds coming from all speakers at the same time.

- Use **↑** or **↓** to set the distance of the surround left speaker from the main listening position (within the range of 0.5 ft. to 45 ft.).



Note

- When **S*** is selected in the speaker setting, the surround speaker distance can't be set.

Subwoofer distance setting

- Default setting: **10 ft.**

Like your speakers, you should set the distance of the subwoofer accurately to hear sounds from all speakers at the same time.

- Use **↑** or **↓** to set the distance of the subwoofer from the main listening position (within the range of 0.5 ft. to 45 ft.).



Note

- When **SW NO** is selected in the subwoofer setting, the subwoofer distance can't be set.

Dynamic range control setting

- Default setting: **OFF**

Dynamic range is the difference between the loudest and softest sounds in any given signal. With this setting, you can compress the dynamic range, so that low level sounds can be heard more easily (sounding relatively louder) yet louder sounds won't be too overbearing.

- Use **↑** or **↓** to set the dynamic range control (**OFF, MAX, or MID**).



Note

- When listening at low volumes, set to **MAX** for maximum dynamic range compression.
- Dynamic range control is effective only when a Dolby Digital or DTS signal is being played back.

Dual mono setting

- Default setting: **ch1**

The dual mono setting can only be used when listening to Dolby Digital and DTS signals with dual mono encoding. It is sometimes used when it is necessary to have one

language on one channel and a different language on the other. With this setting you can choose which channel in the dual mono setting you want to listen to.

If Dolby Digital mode is switched on, you will hear the channel you have selected (either **ch1** or **ch2**) through your center speaker. With Dolby Digital mode off, or if you don't have a center speaker, you will hear the channel you have selected through both front speakers. In the **L ch 1.R ch2** setting, the left front speaker will play channel 1 and the right front speaker will play channel 2.

- Use **↑** or **↓** to cycle through the possible dual mono settings.

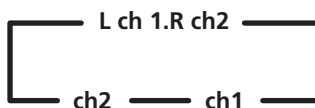

Component video input settings

Here you tell the receiver what components you have hooked up to the component video jacks on the back of the receiver.

Component video 1:

- Default settings: **DVD**
- Use **↑** or **↓** to assign the component video 1 input (**DVD, TV, VCR or OFF**).

Component video 2:

- Default setting: **TV**
- Use **↑** or **↓** to assign the component video 2 input (**DVD, TV, VCR or OFF**).

Setting up the receiver

Surround back channel input setting

(VSX-D812 only)

- Default setting: **SB 2ch IN**

You only have to make this setting if you are using a separate component for decoding DVDs, and the component has only one surround back channel output. If this is the case, select **SB 1ch IN**, otherwise leave it set to **SB 2ch IN**.

- Use **↑** or **↓** to select **SB 2ch IN** or **SB 1ch IN**.

Digital input settings

Here you tell the receiver what components you have hooked up to the coaxial and optical **DIGITAL IN** jacks on the back of the receiver. After you assign a component to a digital jack, whenever you select that component, (for example, a DVD player) the receiver automatically changes to the digital input setting and **DIGITAL** shows in the display.

Coaxial digital 1:

- Default settings: **DVD**
- Use **↑** or **↓** to assign the coaxial digital 1 input (**DVD, TV, CD, CDR, VCR or OFF**).

Coaxial digital 2:

- Default setting: **CD**
- Use **↑** or **↓** to assign the coaxial digital 2 input (**DVD, TV, CD, CDR, VCR or OFF**).

Optical digital 1:

- Default settings: **TV**

- Use **↑** or **↓** to assign the optical digital 1 input (**DVD, TV, CD, CDR, VCR or OFF**).

Optical digital 2

(VSX-D812 only)

- Default setting: **CDR**
- Use **↑** or **↓** to assign the optical digital 2 input (**DVD, TV, CD, CDR, VCR or OFF**).



Note

- You can't assign two inputs to the same function. For example, assigning input 1 to the default setting of input 2 automatically switches input 2 to **OFF**.

Manually calibrating your listening area (MCACC)

You can use the Multi-Channel Acoustic Calibration (MCACC) system to fine tune your speaker levels and channel delay. These are calibrated according to the distance from your left front speaker to the listening position. You will hear a series of test tones that will allow you to set the speaker levels and channel delay to your liking. The advantage of doing this is that you can achieve an overall balance defined by the front speakers (the main speakers for home theater).



Important

- You must complete the *Speaker setting* on page 45 before using the MCACC setup.

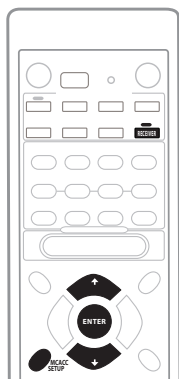

Caution

- These test tones can be loud, so take care that there is no one in the room who will be startled by the noise.

1 Press RECEIVER.

2 Press MCACC SETUP.

The MCACC system uses the left front speaker as a reference point to calibrate the speaker level and channel delay.

The front left speaker tone and the target speaker (the one that you're trying to adjust) tone will sound in turns, so you can judge which needs to be louder.

3 Use ↑ and ↓ to adjust each channel level in turn, pressing ENTER to go to the next channel when you're done.

The test tone is output in the following order (depending on the speaker setting):

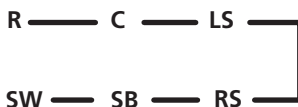

4 Specify the distance from the front left speaker to your listening position using ↑ and ↓ then press ENTER.

5 Use ↑ and ↓ to adjust the delay for each channel in turn, pressing ENTER to go to the next channel when you're done.

Listen to the reference channel and use it to measure the target channel. Stand facing the two speakers with your arms outstretched pointing at each speaker. Try to make the two tones sound as if they are arriving simultaneously at a position slightly in front of you and between your arm span.

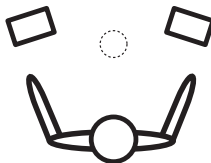

Setting up the receiver

The test tone for channel delay is output in the same order as step 5:

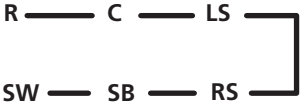

After you have completed all the channels in your speaker setup, the volume level returns to normal and **COMPLETE**, then **RESUME** shows in the display.

Note

- Using the MCACC system to set up your speaker system will overwrite any previous settings you had for the **STANDARD** or **ADVANCED SURROUND** modes.

Setting separate channel levels for listening modes

- Default setting: **0 dB**

In addition to the MCACC setup, you can also set relative channel levels from the listening position using the method below. Using **CH SELECT** (see tip below), it is also possible to set separate channel levels for each of the listening modes.

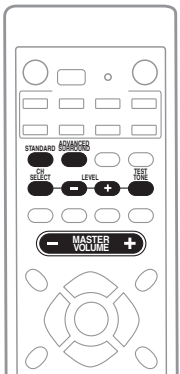

1 Press STANDARD or ADVANCED SURROUND.

2 Press TEST TONE to output the test tone.

The test tone is output in the following order (depending on the speaker setting):

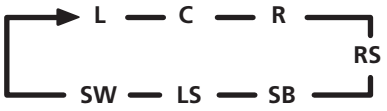

- If you don't hear a test tone from one of your speakers, please refer to *Speaker setting* on page 45 and *Surround back speaker setting* on page 46 to make sure you have correctly specified your speaker setup.

3 Press MASTER VOLUME +/- to adjust the volume to an appropriate level.

4 Use LEVEL +/- to adjust the speaker levels in turn.

You should hear the test tone at the same volume from each speaker when seated in the main listening position. The channel level range is ± 10 dB.

5 When you're done, press TEST TONE to turn off the test tone.

The receiver returns to the Standard mode.



Tip

- The speaker volume can be adjusted without outputting the test tone by pressing **CH SELECT** and then using **LEVEL +/-**. However, you can only adjust the level of the speakers currently active in the mode you're listening to. You can set separate levels for the **STANDARD**, **STEREO** and **DVD 5.1 ch/DVD 7.1 ch** modes, as well as for each **ADVANCED SURROUND** mode.



Note

- Since the subwoofer transmits an ultra-low frequency its sound may seem quieter than it actually is.
- Using test tones to set up your speaker system will overwrite any previous settings you had for the **STANDARD** or **ADVANCED SURROUND** modes.

Chapter 7: Using the tuner

Listening to the radio

The following steps show you how to tune in to FM and AM radio broadcasts using the automatic (search) and manual (step) tuning functions. If you already know the frequency of the station you want, see Tuning directly to a station below. Once you are tuned to a station you can memorize the frequency for recall later—see *Saving station presets* on page 55 for more on how to do this.

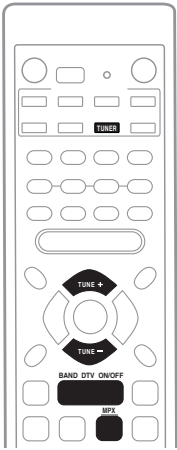

- 1 Press the TUNER button to select the tuner.**
- 2 Use the BAND button to change the band (FM or AM), if necessary.** Each press switches the band between FM and AM.
- 3 Tune to a station.** There are three ways to do this:

Automatic tuning

To search for stations in the currently selected band, press and hold **TUNE +/-** for about a second. The receiver will start searching for the next station, stopping when it has found one. Repeat to search for other stations.

Manual tuning

To change the frequency one step at a time, press **TUNE +/-**.

High speed tuning

Press and hold **TUNE +/-** for high speed tuning. Release the button at the frequency you want.

Improving FM stereo sound

If the **TUNED** or **STEREO** indicators don't light when tuning to an FM station because the signal is weak, press the **MPX** button to switch the receiver into mono reception mode. This should improve the sound quality and allow you to enjoy the broadcast.

Tuning directly to a station

Sometimes, you'll already know the frequency of the station you want to listen to. In this case, you can simply enter the frequency directly using the number buttons on the remote control.

- 1 Press the TUNER button to select the tuner.**
- 2 Use the BAND button to change the band (FM or AM), if necessary.** Each press switches the band between FM and AM.

Using the tuner

3 Press D.ACCESS (Direct Access).

4 Use the number buttons to enter the frequency of the radio station.

For example, to tune to **106.00** (FM), press **1, 0, 6, 0, 0**.

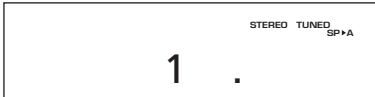

If you make a mistake halfway through, press **D.ACCESS** twice to cancel the frequency and start over.

Saving station presets

If you often listen to a particular radio station, it's convenient to have the receiver store the frequency for easy recall whenever you want to listen to that station. This saves the effort of manually tuning in each time. This unit can memorize up to 30 stations, stored in three banks, or classes, (A, B and C) of 10 stations each. When saving an FM frequency, the **MPX** setting (see page 54) is also stored. Use the front panel controls to store station presets.

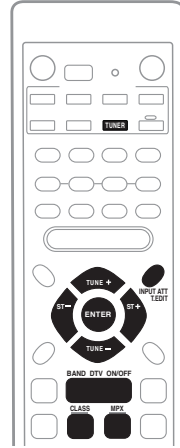
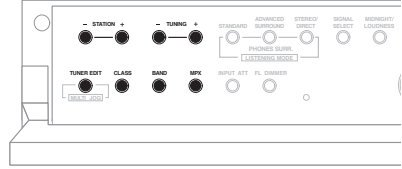
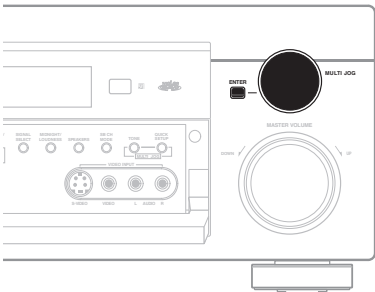

1 Tune to a station you want to memorize.

See *Listening to the radio* on page 54 for more on this.

2 Press T.EDIT (TUNER EDIT).

The display shows **ST. MEMORY**, then a blinking memory class.



3 Press CLASS to select one of the three classes then press ST +/- (STATION +/-) to select the station preset you want.

You can also use the **MULTI JOG** dial (front panel) to select a station preset.

4 Press ENTER.

After pressing **ENTER**, the preset class and number stop blinking and the receiver stores the station.

Naming station presets

For easier identification, you can name your station presets.

1 Choose the station preset you want to name.

See *Listening to station presets* below for how to do this.

2 Press T.EDIT (TUNER EDIT).

The display shows **ST. NAME**, then a blinking cursor at the first character position.

3 Input the name you want.

Names can be up to four characters long.

- Use the **MULTI JOG** dial (front panel) or the **ST +/-** buttons (remote) to select characters.
- Press **ENTER** to confirm a character. If no character is input, a space is input.
- The name is stored when **ENTER** is pressed after choosing the fourth character.

**Tip**

- To erase a station name, simply repeat steps 1-3 and input four spaces instead of a name.
- Once you have named a station preset, you can press **DISPLAY** when listening to a station to switch the display between the name and the frequency.

Listening to station presets

You will need to have some presets stored to do this. See *Saving station presets* on page 55 if you haven't done this already.

1 Press TUNER to select the tuner.**2 Press CLASS to select the class in which the station is stored.**

Press repeatedly to cycle through classes A, B and C.

3 Press ST +/- (STATION +/-) to select the station preset you want.**Note**

- If the receiver is left disconnected from the AC power outlet for an extended period, the station memories will be lost and will have to be reprogrammed.

Chapter 8: Making recordings

Making an audio or a video recording

You can make an audio or a video recording from the built-in tuner, or from an audio or video source connected to the receiver (such as a CD player or TV).

Keep in mind you can't make a digital recording from an analog source or vice-versa, so make sure the components you are recording to/from are hooked up in the same way (see *Connecting up* on page 15 for more on connections).

If you want to record a video source, you also need use the same type of connection for the source as for the recorder. For example, you can't record a component hooked up to S-video jacks with a recorder hooked up to the component video outputs (see page 19 for more on video connections).

1 Select the source you want to record.
Use the **MULTI CONTROL** buttons (or **INPUT SELECT**).

2 Select the input signal (if necessary).
Press **SIGNAL SELECT** (front panel) to select the input signal corresponding to the source component (see page 37 for more on this).

3 Prepare the source you want to record.
Tune to the radio station, load the CD, video, DVD etc.

4 Prepare the recorder.
Insert a blank tape, MD, video etc. into the recording device and set the recording levels. Refer to the instructions that came with the recorder if you are unsure how to do this. Most video recorders set the audio recording level automatically—check the component's instruction manual if you're unsure.

5 Start recording, then start playback of the source component.

 **Note**

- The receiver's volume, balance, tone (bass, treble, loudness), and surround effects have no effect on the recorded signal.

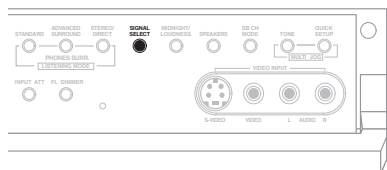
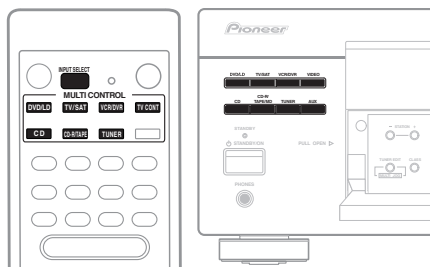

Chapter 9: Controlling the rest of your system

Setting the remote to control other components

There are several ways to set your remote to control the other components in your system. The easiest way to do this is to assign the component's manufacturer preset code (starting on page 63) to one of the **MULTI CONTROL** buttons on the remote control.

The buttons can be set to control the following components:

Button	Controllable Components
DVD/LD:	DVD or LD player
TV/SAT:	TV or Satellite tuner
VCR/DVR:	VCR or Digital Video Recorder
CD:	CD player
CD-R/TAPE:	CD Recorder, Tape deck or MD player
TV CONT:	TV or Cable TV tuner
TUNER:	FM/AM tuner

 **Note**

- The remote control will exit an operation after 1 minute of inactivity.

Selecting preset codes directly

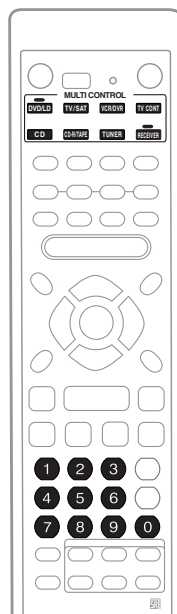

1 While pressing the RECEIVER button, press and hold the 1 button.

The LED blinks.

2 Press the MULTI CONTROL button for the component you want to control.

The LED lights.

3 Use the number buttons to enter the preset code (see page 63)

The LED blinks again.

If the correct code has been input the power of the component being input will turn on or off.

The power of the component being input will only turn on or off if that component is able to be turned on directly by remote control.

- You can only input a code for the component type written on each **MULTI CONTROL** button (except **RECEIVER** and **TUNER**).
- Even if you don't input a preset code for the TV (**TV/SAT MULTI CONTROL** button) you will be able to control your TV using the dedicated **TV CONTROL** on the remote if you have assigned it to the **TV CONT** button.
- You may not be able to use a particular code even if it is listed on page 63.
- The remote control buttons will not be able to operate other equipment unless preset with the method above.

4 Repeat steps 2 through 3 to try a different code, or to enter a code for another component you want to control.

5 When you're done, press RECEIVER.

Clearing all the remote control settings

You can clear all presets and restore the factory default settings.

- **While pressing the RECEIVER button, press and hold the 0 button for three seconds.**

The LED blinks three times indicating the settings have been restored to the factory presets.

Direct function

- Default setting: **ON**

You can use the direct function feature to control one component using the remote control while at the same time, using your receiver to playback a different component. This could let you, for example, use the remote control to set up and listen to a CD on the receiver and then use the remote control to rewind a tape in your VCR while you continue to listen to your CD player.

When direct function is on, any component you select (using the **MULTI CONTROL** buttons) will be selected by both the receiver and the remote control. When you turn direct function off, you can operate the remote control without affecting the receiver.

1 While pressing the RECEIVER button, press and hold the 4 button.

The LED blinks.

2 Press the MULTI CONTROL button for the component you want to control.

The LED lights.

3 Use the number buttons to enter either 1 (direct on) or 2 (direct off).

The LED blinks again.

4 Repeat steps 2 through 3 for the other components you want to control.

5 When you're done, press RECEIVER.











Note

- You can't use direct function for **TUNER**.

Controls for TVs

This remote control can control components after entering the proper codes or teaching the receiver the commands (see *Setting the remote to control other components* on page 58 for more on this). Use the **MULTI CONTROL** buttons to select the component.

Button(s)	Function	Components
TV 	Switches the DTV on or off.	DTV
	Switches the TV or CATV between standby and on.	Cable TV/Satellite TV/TV
INPUT SELECT	Switches the TV input. (Not possible with all models.)	TV
CHANNEL +/-	Selects channels.	Cable TV/Satellite TV/TV/DTV
VOLUME +/-	Adjust the TV volume.	Cable TV/Satellite TV/TV/DTV
TOP MENU	Press to display the DTV menu.	DTV
MENU	Select different menus from the DTV functions.	DTV
	Select the menu screen.	Cable TV/Satellite TV/TV
AUDIO	Use to switch DTV audio tracks	DTV
GUIDE	Use as the GUIDE button for navigating	DTV
	Use to choose the BLUE commands on a DTV menu.	DTV
	Use to choose the GREEN commands on a DTV menu.	DTV
	Use to choose the RED commands on a DTV menu.	DTV
	Use to choose the YELLOW commands on a DTV menu.	DTV
	Press to get information on DTV programs.	DTV
	Switches DTV on or off.	DTV
	Use to select closed captioning with DTV.	DTV
Number Buttons	Use to select a specific TV channel.	Cable TV/Satellite TV/TV/DTV
+10 button	Use to add a decimal point when selecting a specific TV channel.	DTV
ENTER/DISC	Use to enter a channel.	Cable TV/Satellite TV/TV/DTV

Button(s)	Function	Components
↔ ↑ ↓ & ENTER	Select or adjust and navigate items on the menu screen. ENTER brings up the DTV menus.	DTV
	Press to select or adjust and navigate items on the menu screen.	Cable TV/Satellite TV/TV/DTV



Note

- The four **TV CONTROL** buttons on the remote control are dedicated to control the TV assigned to the **TV CONT** button. Thus if you only have one TV to hook up to this system assign it to the **TV CONT MULTI CONTROL** button. If you have two TVs, assign the main TV to the **TV CONT** button.

Controls for other components

This remote control can control these components after entering the proper codes or teaching the receiver the commands (see *Setting the remote to control other components* on page 58 for more on this). Use the **MULTI CONTROL** buttons to select the component.

Button (s)	Function	Components
SOURCE	Press to switch the component between standby and on.	CD/MD/CD-R/VCR/DVD/LD/DVR player/Cassette deck
⏮	Press to return to the start of the current track. Repeated presses skips to the start of previous tracks.	CD/MD/CD-R/DVD/LD player
	Play the reverse side of the tape on a reversible deck.	Cassette deck
⏭	Press to advance to the start of the next track. Repeated presses skips to the start of following tracks.	CD/MD/CD-R/DVD/LD player
	Play the forward side of the tape on a reversible deck.	Cassette deck
⏸	Pause playback or recording.	CD/MD/CD-R/VCR/DVD/LD/DVR player/Cassette deck
▶	Start playback.	CD/MD/CD-R/VCR/DVD/LD/DVR player/Cassette deck
⏩	Hold down for fast forward playback.	CD/MD/CD-R/VCR/DVD/LD/DVR player/Cassette deck
⏪	Hold down for fast reverse playback.	CD/MD/CD-R/VCR/DVD/LD/DVR player/Cassette deck
■	Stops playback (on some models, pressing this when the disc is already stopped will cause the disc tray to open).	CD/MD/CD-R/VCR/DVD/LD/DVR player/Cassette deck

Button (s)	Function	Components
Number buttons	Directly access tracks on a program source.	CD/MD/CD-R/VCR/LD player
	Use the number buttons to navigate the on-screen display.	DVD/DVR player
+10 button	Selects tracks higher than 10. (For example, press +10 then 3 to select track 13.)	CD/MD/CD-R/VCR/LD player
ENTER/DISC	Changes the search mode.	DVD
	Chooses the disc.	Multiple CD player
	Use as the ENTER button.	VCR
	Displays the setup screen for DVR players.	DVR player
	Changes sides of the LD.	LD player
MENU	Displays menus concerning the current DVD or DVR you are using.	DVD/DVR player
↑	Pauses the tape.	Cassette deck
↓	Stops the tape.	Cassette deck
ENTER	Starts playback.	Cassette deck
↔	Fast rewinds/fast forwards the tape.	Cassette deck
↔ ↑ ↓ & ENTER	Navigates DVD menu/options.	DVD/DVR Player
CHANNEL +/-	Selects channels.	VCR/DVD/DVR Player
TOP MENU	Displays the disc 'top' menu of a DVD.	DVD/DVR Player
AUDIO	Changes the audio language or channel.	DVD/DVR Player
GUIDE	Displays/changes the subtitles on multilingual DVDs.	DVD/DVR Player

Preset Code List

You should have no problem controlling a component if you find the manufacturer in this list, but please note that there are cases where codes for the manufacturer in the list will not work for the model that you are using. There are also cases where only certain functions may be controllable after assigning the proper preset code.



Note

- The TV, STB and DTV codes can only be set to the **TV/SAT** or **TV CONT** button.

DVD

Manufacturer Code

TOSHIBA 001
SONY 002
PANASONIC 003
JVC 004
SAMSUNG 005
SHARP 006
AKAI 007
RCA 009, 011
DENON 003, 010
HITACHI 012
PHILIPS 013
ZENITH 014
SONY 016 (video game)
LOEWE 013
GOLDSTAR 014
MICROSOFT
 017 (Videogame)
PIONEER 000, 003, 008, 111

LD

Manufacturer Code

SONY 101
PANASONIC 105, 106
PHILIPS 104
KENWOOD 103
MITSUBISHI 100
RCA 107
PIONEER 100, 111 (DVDLD)

TV TV/SAT TV/CONT

Manufacturer Code

RCA 601, 610, 615, 616, 617, 618, 661, 662, 609
ZENITH 603, 620
MAGNAVOX 607, 610, 603, 612, 629

GE 601, 608, 607, 610, 617, 602, 628, 618

PHILIPS 607

SONY 604

PANASONIC 607, 608, 622

TOSHIBA 605, 602, 626, 621

SHARP 602, 619, 627

HITACHI 606, 610, 624, 625, 618

SANYO 621, 614

MITSUBISHI 609, 610, 602, 621

GOLDSTAR 610, 623, 621, 602

JVC 613, 623

RADIOSHACK 610, 623, 621, 602

FUNAI 658

GRADIENTE 630

LOEWE 607

PIONEER 600

STB (SATELLITE/

CATV) TV/SAT TV/CONT

Manufacturer Code

JERROLD 711, 701, 702, 712, 704, 713, 703, 714, 716, 715

S. ATLANTA 705, 706, 708, 709

ZENITH 707, 717, 710

PIONEER 700

On digital STB

TV/SAT TV/CONT

Manufacturer Code

RCA 201, 203

SONY 202

ECHOSTAR 205

PRIMESTAR 206

BELL 208

PIONEER 200, 207, 231

DTV TV/SAT TV/CONT

Manufacturer Code

PIONEER 229, 207

PANASONIC 230

TUNER

Manufacturer Code

PIONEER 500

VCR

Manufacturer Code

ORION 445, 446, 424

FUNAI 441

RCA 401, 406, 408, 414, 405, 413, 411, 415, 460, 461, 462, 463, 435

ZENITH 403, 404, 417

MAGNAVOX 414, 408, 426, 403

FISHER 410, 426, 412, 427, 425, 420

PANASONIC 408, 432, 433

TOSHIBA 405, 409, 426

JVC 428, 430, 429, 408, 414, 431, 407

HITACHI 408, 401, 406, 436, 434

SONY 416, 417, 404, 408, 457, 458, 459

MITSUBISHI

409, 420, 421, 422, 423, 424, 408, 407, 456

SANYO 410, 412, 425, 435

SHARP 402, 418, 419, 456

GOLDSTAR 411, 409

OPTIMUS 408, 432, 433, 402, 418, 419

GRADIENTE 441

LOEWE 414, 432

KENWOOD 456

PIONEER 400

DVD Recorder

Manufacturer Code

PIONEER 456

TAPE

Manufacturer Code

DENON 810

FISHER 813

JVC 802

KENWOOD 804, 807

MARANTZ 821

ONKYO 808, 809

OPTIMUS 800

SONY 801, 806

TEAC 805

TECHNICS 803

YAMAHA 811, 812

PIONEER 800

CD

Manufacturer Code

DENON 309, 346

JVC 303

KENWOOD 310, 311, 321

MARANTZ 323, 312, 324, 346

ONKYO 320, 308, 307

OPTIMUS 300

PHILIPS 312, 322, 346

RCA 302, 319, 313

SANYO 313

SONY 301, 316, 317, 318

TEAC 305, 306, 327, 324,
325

TECHNICS 304, 326

YAMAHA 315, 314, 328,
347

PIONEER 300, 345

MD

Manufacturer Code

SONY 901

KENWOOD 903

SHARP 902

TEAC 904

ONKYO 905

DENON 906

PIONEER 900, 902, 907

Chapter 10: Additional information

Troubleshooting

Incorrect operations are often mistaken for trouble and malfunctions. If you think that there is something wrong with this component, check the points below. Sometimes the trouble may lie in another component. Investigate the other components and electrical appliances being used. If the trouble cannot be rectified even after exercising the checks listed below, ask your nearest Pioneer authorized service center or your dealer to carry out repair work.

Problem	Remedy
The power does not turn on.	<ul style="list-style-type: none"> • Connect the power plug to the wall outlet. • Disconnect the power plug from the outlet, and insert again. • Make sure there are no loose strands of speaker wire touching the rear panel. This could cause the receiver to shut off automatically. • If the STANDBY indicator blinks and the power shuts off automatically, take the unit to your nearest Pioneer authorized service center or your dealer for servicing.
No sound is output when a function is selected.	<ul style="list-style-type: none"> • Make sure the component is connected correctly (refer to <i>Connecting up</i> on page 15). • Press MUTE on the remote control to turn muting off. • Adjust the MASTER VOLUME.
No image is output when a function is selected.	<ul style="list-style-type: none"> • Make sure the component is connected correctly (refer to <i>Connecting up</i> on page 15). • Select the correct component (use the MULTI CONTROL buttons).
Considerable noise in radio broadcasts.	<ul style="list-style-type: none"> • Tune in the correct frequency. • Connect the antenna (refer to page 20). • Route any loose cables away from the antenna terminals and wires. • Fully extend the FM wire antenna, position for best reception, and secure to a wall. • Connect an outdoor FM antenna (refer to page 20). • Adjust the direction and position for best reception. • Connect an additional internal or external AM antenna (refer to page 20). • Turn off the equipment causing the noise or move it away from the receiver. • Place the antenna farther away from the equipment causing the noise.

Problem	Remedy
Broadcast stations cannot be selected automatically.	<ul style="list-style-type: none"> • Connect an outdoor antenna (refer to page 20).
No sound from surround or center speakers.	<ul style="list-style-type: none"> • Refer to <i>Speaker setting</i> on page 45 to check the speaker settings. • Refer to <i>Manually calibrating your listening area (MCACC)</i> on page 51 to check the speaker levels. • Connect the speakers properly (refer to page 21 or page 22).
No sound from surround back speakers.	<ul style="list-style-type: none"> • Refer to <i>Surround back speaker setting</i> on page 46 to check the surround back speaker settings. • Refer to <i>Using the Surround Back Channel (SB CH)</i> on page 40 to make sure the SB CH MODE and the sound mode are set for surround back sound.
No sound from subwoofer.	<ul style="list-style-type: none"> • Make sure the subwoofer is switched on. • If the subwoofer has a volume knob, make sure it's turned up. • Switch the <i>Subwoofer setting</i> on page 46 to YES or PLUS. • Switch the <i>LFE attenuator setting</i> on page 47 to 0 dB or 10 dB. • The Dolby Digital or DTS source you are listening to does not have an LFE channel.
Noise during playback of a cassette deck.	<ul style="list-style-type: none"> • Move the cassette deck further from your receiver, until the noise disappears.
Sound is produced from other components, but not from LD or DVD player.	<ul style="list-style-type: none"> • Set the SIGNAL SELECT to AUTO, DIGITAL or ANALOG according to the type of connections made. (refer to page 37). • Set the digital input settings correctly (refer to page 50). • Make digital connections (refer to page 16) and set the SIGNAL SELECT to DIGITAL (refer to page 37). • Refer to the instruction manual supplied with the DVD player.
No sound is output or a noise is output when software with DTS is played back.	<ul style="list-style-type: none"> • Set the digital volume level of the player to full, or to the neutral position.
When a search is performed by a DTS compatible CD player during playback, noise is output.	<ul style="list-style-type: none"> • This is not a malfunction, but be sure to turn the volume down to prevent the output of loud noise from your speakers.
Can't operate the remote control.	<ul style="list-style-type: none"> • Replace the batteries (refer to page 6). • Operate within 23 feet (7 m), 30° of the remote sensor on the front panel (refer to page 7). • Remove the obstacle or operate from another position. • Avoid exposing the remote sensor on the front panel to direct light.
The display is dark or off.	<ul style="list-style-type: none"> • Press FL DIMMER on the remote control repeatedly to return to the default.

**Note**

- If the unit does not operate normally due to external effects such as static electricity disconnect the power plug from the outlet and insert again to return to normal operating conditions.

Resetting the main unit

Use this procedure to reset all the receiver's settings to the factory default. Use the front panel controls to do this.

1 Switch the receiver on.

2 While holding down the TONE button, press and hold the  STANDBY/ON button for about three seconds.

3 When you see RESET? appear in the display, press the TONE button.

OK? shows in the display.

4 Press TONE once more to confirm.

OK appears in the display to indicate that the receiver has been reset to the factory default settings.

Specifications

Amplifier section

Continuous average power output of 100 watts* per channel, min., at 8 ohms, from 20 Hz to 20,000 Hz with no more than 0.2 %** total harmonic distortion (front).

Continuous power output (stereo)

Front. 100 W per channel
(20–20,000 Hz, THD 0.2 %, 8 Ω)

Continuous power output (surround)

Front. 100 W per channel
(1kHz, 1.0 %, 8 Ω)
Center 100 W (1kHz, 1.0 %, 8 Ω)
Surround 100 W per channel
(1kHz, 1.0 %, 8 Ω)
Surround Back 100 W per channel
(*VSX-D812 only*) (1kHz, 1.0 %, 8 Ω)

Input (Sensitivity/Impedance)

CD, VCR/DVR, CD-R/TAPE/MD,
DVD/LD, TV/SAT 200 mV/47 k Ω

Frequency response

CD, VCR/DVR, CD-R/TAPE/MD, DVD/LD,
TV/SAT 5 Hz to 100,000 Hz ± 3 dB

Output (Level/Impedance)

VCR/DVR REC, CD-R/TAPE/
MD REC. 200 mV/2.2 k Ω

Tone control

Bass ± 6 dB (100 Hz)
Treble ± 6 dB (10 kHz)
Loudness +6.5 dB/+3 dB (100 Hz/10 kHz)
(at volume level -50 dB)

Signal-to-Noise Ratio

(IHF, short circuited, A network)

CD, VCR/DVR, CD-R/TAPE/MD,
DVD/LD, TV/SAT 96 dB

Signal-to Noise Ratio

EIA, at 1 W (1 kHz)

CD, VCR/DVR, CD-R/TAPE/MD,
DVD/LD, TV/SAT. 79 dB

Video section

Input (Sensitivity/Impedance)

VCR/DVR, DVD/LD, TV/SAT 1 V_{p-p}/75 Ω

Output (Level/Impedance)

VCR/DVR, MONITOR OUT 1 V_{p-p}/75 Ω

Frequency response

VCR/DVR, DVD/LD,
TV/SAT \Rightarrow MONITOR. 5 Hz to 7 MHz ± 3 dB
Signal-to-Noise Ratio. 55 dB

Component video section

Input (Sensitivity)

DVD/LD, TV/SAT. 1 V_{p-p}/75 Ω

Output (Level/Impedance)

MONITOR OUT. 1 V_{p-p}/75 Ω

Frequency response

DVD/LD,
TV/SAT \Rightarrow MONITOR. 5 Hz to 40 MHz ± 3 dB
Signal-to-Noise Ratio. 55 dB

FM tuner section

Frequency Range. 87.5 MHz to 108 MHz
Usable Sensitivity Mono:13.2 dBf, IHF
(1.3 μ V/ 75 Ω)
50 dB Quieting Sensitivity. Mono: 20.2 dB
. Stereo: 38.6 dBf
Signal-to-Noise Ratio. Mono: 73 dB
(at 85 dBf)
Stereo: 70 dB (at 85 dBf)
Distortion Stereo: 0.5 % (1 kHz)
Alternate Channel Selectivity 60 dB
(400 kHz)

Additional information

Stereo Separation	40 dB (1 kHz)
Frequency Response	30 Hz to 15 kHz (±1 dB)
Antenna Input (DIN)	75 Ω unbalanced

AM tuner section

Frequency Range	530 kHz to 1,700 kHz
Sensitivity (IHF, Loop antenna)	350 μ V/m
Selectivity	25 dB
Signal-to-Noise Ratio	50 dB
Antenna	Loop antenna

Miscellaneous

Power Requirements	AC 120 V, 60Hz
Power Consumption	
VSX-D812	300W, 420 VA
VSX-D712	260W, 340 VA
In standby	0.5 W
AC Outlet	100 W MAX. (SWITCHED)
Dimensions	420 (W) x 158 (H) x 401 (D) mm (16-9/16 (W) x 6-4/16 (H) x 15-6/16 (D) in.)
Weight (without package)	
VSX-D812	10.5 kg (23.1 lb)
VSX-D712	9.0 kg (19.8 lb)

Furnished parts

AM loop antenna	1
FM wire antenna	1
AA/R6 dry cell batteries	2
Remote control	1
These operating instructions	1



Note

- Specifications and the design are subject to possible modifications without notice, due to improvements.

* Measured pursuant to the Federal Trade Commission's Trade Regulation rule on Power Output Claims for Amplifiers.

** Measured by Audio Spectrum Analyzer.

Cleaning the unit

- Use a polishing cloth or dry cloth to wipe off dust and dirt.
- When the surface is dirty, wipe with a soft cloth dipped in some neutral cleanser diluted five or six times with water, and wrung out well, and then wipe again with a dry cloth. Do not use furniture wax or cleansers.
- Never use thinners, benzine, insecticide sprays or other chemicals on or near this unit, since these will corrode the surface.



Dear Customer:

Selecting fine audio equipment such as the unit you've just purchased is only the start of your musical enjoyment. Now it's time to consider how you can maximize the fun and excitement your equipment offers. This manufacturer and the Electronic Industries Association's Consumer Electronics Group want you to get the most out of your equipment by playing it at a safe level. One that lets the sound come through loud and clear without annoying blaring or distortion—and, most importantly, without affecting your sensitive hearing.

Sound can be deceiving. Over time your hearing "comfort level" adapts to higher volumes of sound. So what sounds "normal" can actually be loud and harmful to your hearing. Guard against this by setting your equipment at a safe level BEFORE your hearing adapts.

To establish a safe level:

- Start your volume control at a low setting.
- Slowly increase the sound until you can hear it comfortably and clearly, and without distortion.

Once you have established a comfortable sound level:

- Set the dial and leave it there.

Taking a minute to do this now will help to prevent hearing damage or loss in the future. After all, we want you listening for a lifetime.

We Want You Listening For A Lifetime

Used wisely, your new sound equipment will provide a lifetime of fun and enjoyment. Since hearing damage from loud noise is often undetectable until it is too late, this manufacturer and the Electronic Industries Association's Consumer Electronics Group recommend you avoid prolonged exposure to excessive noise. This list of sound levels is included for your protection.

Decibel

Level	Example
30	Quiet library, soft whispers
40	Living room, refrigerator, bedroom away from traffic
50	Light traffic, normal conversation, quiet office
60	Air conditioner at 20 feet, sewing machine
70	Vacuum cleaner, hair dryer, noisy restaurant
80	Average city traffic, garbage disposals, alarm clock at two feet.

THE FOLLOWING NOISES CAN BE DANGEROUS UNDER CONSTANT EXPOSURE

90	Subway, motorcycle, truck traffic, lawn mower
100	Garbage truck, chain saw, pneumatic drill
120	Rock band concert in front of speakers, thunderclap
140	Gunshot blast, jet plane
180	Rocket launching pad

Information courtesy of the Deafness Research Foundation.



S001 en

Should this product require service in the U.S.A. and you wish to locate the nearest Pioneer Authorized Independent Service Company, or if you wish to purchase replacement parts, operating instructions, service manuals, or accessories, please call the number shown below.

8 0 0 - 4 2 1 - 1 4 0 4

Please do not ship your product to Pioneer without first calling the Customer Support Division at the above listed number for assistance.

Pioneer Electronics (USA) Inc.
Customer Support Division
P.O. BOX 1760, Long Beach,
CA 90801-1760, U.S.A.

For warranty information please see the Limited Warranty sheet included with your product.

Should this product require service in Canada, please contact a Pioneer Canadian Authorized Dealer to locate the nearest Pioneer Authorized Service Company in Canada.
Alternatively, please contact the Customer Satisfaction Department at the following address:

Pioneer Electronics of Canada, Inc.
Customer Satisfaction Department
300 Allstate Parkway, Markham, Ontario L3R OP2
(905)479-4411
1(877)283-5901

For warranty information please see the Limited Warranty sheet included with your product.

Si ce produit doit être réparé au Canada, veuillez vous adresser à un distributeur autorisé Pioneer du Canada pour obtenir le nom du Centre de Service Autorisé Pioneer le plus près de chez-vous. Vous pouvez aussi contacter le Service à la clientèle de Pioneer:

Pioneer Electroniques du Canada, Inc.
Service à la clientèle
300, Allstate Parkway, Markham, Ontario L3R OP2
(905)479-4411
1(877)283-5901

Pour obtenir des renseignements sur la garantie, veuillez vous reporter au feuillet sur la garantie restreinte qui accompagne le produit.

S018D_enfr

Published by Pioneer Corporation
Copyright©2002 Pioneer Corporation
All rights reserved

PIONEER CORPORATION

4-1, Meguro 1-Chome, Meguro-ku, Tokyo 153-8654, Japan

PIONEER ELECTRONICS (USA) INC.

P.O. BOX 1540, Long Beach, California 90810-1540, U.S.A. TEL: (800) 421-1404

PIONEER ELECTRONICS OF CANADA, INC.

300 Allstate Parkway, Markham, Ontario L3R OP2, Canada TEL: (905) 479-4411

PIONEER EUROPE NV

Haven 1087, Keetberglaan 1, B-9120 Melsele, Belgium TEL: 03/570.05.11

PIONEER ELECTRONICS ASIACENTRE PTE. LTD.

253 Alexandra Road, #04-01, Singapore 159936 TEL: 656-472-1111

PIONEER ELECTRONICS AUSTRALIA PTY. LTD.

178-184 Boundary Road, Braeside, Victoria 3195, Australia, TEL: (03) 9586-6300

PIONEER ELECTRONICS DE MEXICO S.A. DE C.V.

Bldv.Manuel Avila Camacho 138 10 piso Col.Lomas de Chapultepec, Mexico,D.F. 11000 TEL: 55-9178-4270